



服务热线: 400-600-6180



蜚誉全球 日丽风清

# VACUUM CLEANER PICTURE ALBUM

工业吸尘器产品展示

专业、高效、安全的工业清洁设备  
Professional, efficient and safe industrial cleaning equipment



微信公众号



官方网站



阿里巴巴网站



生产厂: 全风环保科技股份有限公司  
电话: 0086-025-57800186  
地址: 南京市高淳区经济开发区凤山路5-8号

Manufacturing plant: Quanfeng Environmental Protection Technology Co., Ltd.  
TEL: 0086-025-57800186  
ADD: No.5-8, Fengshan Road, economic development zone, Gaochun District, Nanjing

制造商: 上海全风实业有限公司  
电话: 0086-021-33502971 33502951  
传真: 0086-021-33588692  
网址: www.shquanfeng.com  
地址: 上海市松江区九亭镇九新公路338号

Manufacturer: Shanghai Quanfeng Industry Co., Ltd.  
TEL: 0086-021-33502971 33502951  
FAX: 0086-021-33588692  
ADD: No.103, no.338, qiujing road, jiuting town, songjiang district, Shanghai, China

生产厂: 江苏全风环保科技有限公司  
电话: 0086-0510-81612026  
传真: 0086-0510-81612056  
网址: www.jsqfkj.cn  
地址: 江苏省无锡市青阳工业园润阳路8号

Manufacturing plant: Jiangsu Quanfeng environmental protection technology Co., Ltd.  
TEL: 0086-0510-81612026  
FAX: 0086-0510-81612056  
ADD: No.8, runyang road, qingyang industrialpark, wuxi city, JS, China

华南区: 东莞市全风环保科技有限公司  
电话: 0086-0769-81696369  
地址: 东莞市厚街镇桥头社区祠边小区29号4楼

South China: Dongguan Quanfeng environmental protection technology Co., Ltd.  
TEL: 0086-0769-81696369  
ADD: No 29, 4 building, Qiaotou community, Houjie Town, Dongguan city

华东区: 苏州全风环保科技有限公司  
地址: 苏州市相城区金澄路88号

East China: Suzhou Quanfeng Environmental Protection Technology Co., Ltd.  
ADD: No.88 Jincheng Road, Xiangcheng District, Suzhou

华东区: 上海与鑫机电科技有限公司  
电话: 0086-021-33502971 33502951  
传真: 0086-021-33588692  
网址: www.twyxsh.com

East China: Shanghai Yuxin Electrical and Mechanical Technology Co., Ltd.  
TEL: 0086-021-33502971 33502951  
FAX: 0086-021-33588692

华北区: 北京全风机电设备有限公司  
电话: 0086-010-59406010 59496011  
传真: 0086-010-87660057  
网址: www.bjtwyx.com

North China: Beijing Quanfeng Electromechanical Equipment Co., Ltd.  
TEL: 0086-010-59496010 59496011  
FAX: 0086-010-87660057

**全风环保科技股份有限公司**  
Quanfeng Environmental Protection Technology Co., Ltd.

## ABOUT QUANFENG 关于全风



全风环保科技股份有限公司是一家专业从事空气流体设备、环保设备（压缩、真空）生产及销售一体化的现代化企业，通过多年的发展，公司以高压风机，其它空气流体设备（真空泵和鼓风机），有着专业的设计研发团队，团队成员本着与时俱进的发展原则，在真空吸尘除尘领域，不断开拓创新。设计研发出一款款适用于工业领域的工业真空吸尘设备，解决了一系列工业除尘中所面临难题，使得原本繁琐缓慢的清洁除尘工作变得简单快捷。为客户解决了一系列难题。

在“以服务求生存，以质量求发展，诚信为本，实现共赢”的经营理念下。我们凭借专业的生产技术、智能生产设备、人性化的管理模式，竭诚为客户提供优质、高效、节能的全系列高压风机产品。为了实现了产品生产的标准化及一致性，我司引进配备了大批大族激光和宏山板管激光及亚威折弯机、优尼斯（i5全智能数控机床）数控车削中心及大型加工中心、卧式动平衡机、自动烘漆流水线等高科技含量的生产及检测设备。为了与欧洲发达国家的产品接轨，我司所有系列产品均按照宽电压、宽频率的欧洲标准所设计。每年都有数以万计的产品出口到欧洲，美洲，澳洲，中东，东南亚等数十个国家，产品享誉全球。

为了尽可能的满足客户需求，我司可以根据客户要求，定制特殊规格（防腐、防爆、耐高温等）的高品质产品，以便为客户提供更好的服务。

好的产品，好的服务，好的信誉，全风环保科技股份有限公司在燃料机、上料机、吹塑机以及污水处理等众多行业取得了辉煌成绩，完成众多大型环保设备的配套服务，也愿意成为您的长期合作伙伴。

Quanfeng Environmental Protection Technology Co., Ltd. is a modern enterprise specializing in the production and sales integration of air fluid equipment and environmental protection equipment (compression, vacuum). Through years of development, the company has a professional design and R & D team of high-pressure fans and other air fluid equipment (vacuum pumps and blowers). Based on the development principle of keeping pace with the times, the team members are in the real world In the field of air cleaning and dust removal, continuous development and innovation. A series of industrial vacuum cleaning equipment is designed and developed, which can solve a series of problems in industrial dust removal, and make the original tedious and slow cleaning and dust removal work simple and fast. For customers to solve a series of problems.

Under the business philosophy of "service for survival, quality for development, integrity-based, win-win". We rely on professional production technology, intelligent production equipment, humanized management mode, dedicated to provide customers with high-quality, efficient, energy-saving full range of high-pressure fan products. In order to achieve the standardization and consistency of product production, our company has introduced a large number of high-tech production and testing equipment, such as Han's laser, Hongshan plate tube laser, Yawei bending machine, Younis (i5 fully intelligent CNC machine tool) CNC turning center and large machining center, horizontal dynamic balancing machine, automatic paint drying flow line, etc. In order to connect with the products of developed countries in Europe, all our products are designed according to the European standard of wide voltage and wide frequency. Every year, tens of thousands of products are exported to Europe, America, Australia, the Middle East, Southeast Asia and other dozens of countries.

In order to meet the needs of customers as much as possible, our company can customize high-quality products with special specifications (anti-corrosion, explosion-proof, high temperature resistance, etc.) according to the requirements of customers, so as to provide better services for customers.

With good products, good service and good reputation, Quanfeng Environmental Protection Technology Co., Ltd. has made brilliant achievements in many industries such as fuel machine, feeding machine, blow molding machine and sewage treatment. It has completed supporting services for many large-scale environmental protection equipment and is willing to become your long-term partner.



斐登全球  
日丽风清



经营理念  
MANAGEMENT IDEA

以质量求生存，以创新求发展，诚信为本，实现共赢  
To the quality of survival, innovation and development, honesty, and achieve win-win situation

质量方针  
QUALITY POLICY

以精立业，以质取胜，客户满意是企业永恒的追求  
With the essence of enterprise, quality, customer satisfaction is the eternal pursuit of enterprises

公司宗旨  
COMPANY TENET

以人才和技术为基础，创造优质产品和服务  
Create quality products and services based on talent and technology

企业精神  
ENTERPRISE SPIRIT

团结、创新、诚信、共赢  
Unity, innovation, honesty and win-win

# QUALIFICATION CERTIFICATE

## 资质证书



荣誉是业界对全风的一种肯定、一种鼓舞，是全风发展逐级向上的台阶。我们始终坚持“客户有益、员工有益、社会有益”的企业价值观以科学人性化的管理赢得员工的支持，以特色优质的服务赢得客户的信任，以认真、负责、奉献的实际行动赢得社会的肯定。

Honor is the industry's affirmation and encouragement to the whole wind. It is a step up step by step for the development of the whole wind. We always adhere to the enterprise values of "customer benefit, employee benefit, social benefit" to win the support of employees with scientific and human management, to win the trust of customers with high quality service, to earnestly, responsibly, dedicated to the actual action to win the recognition of the community.

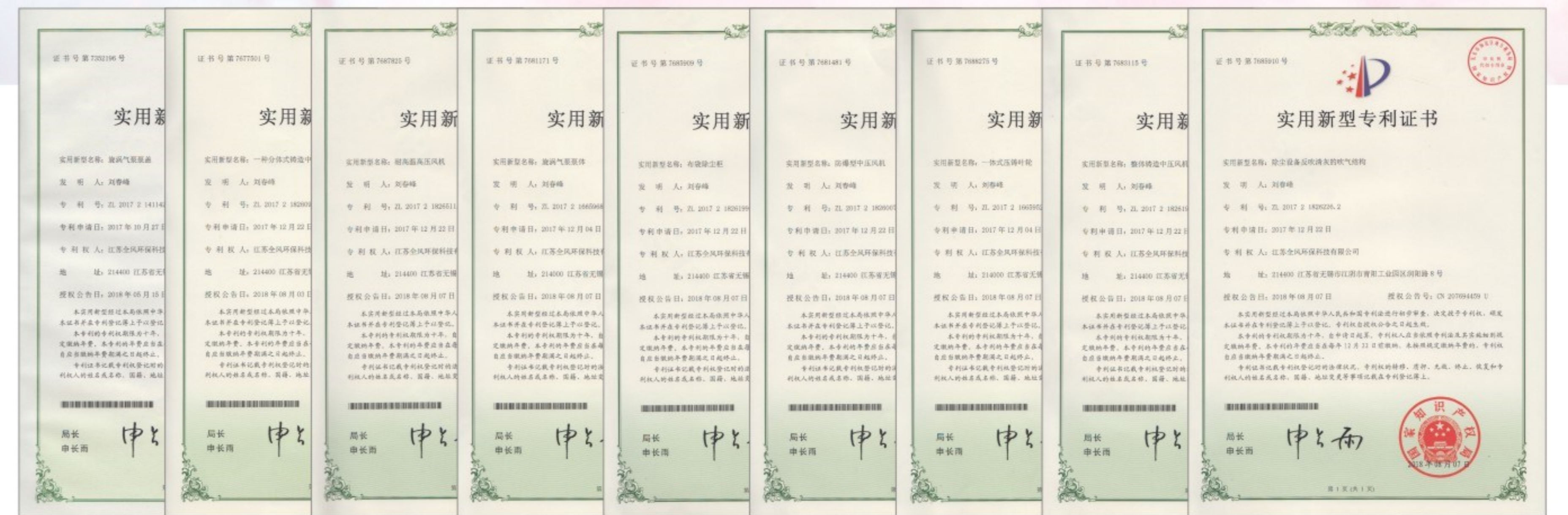
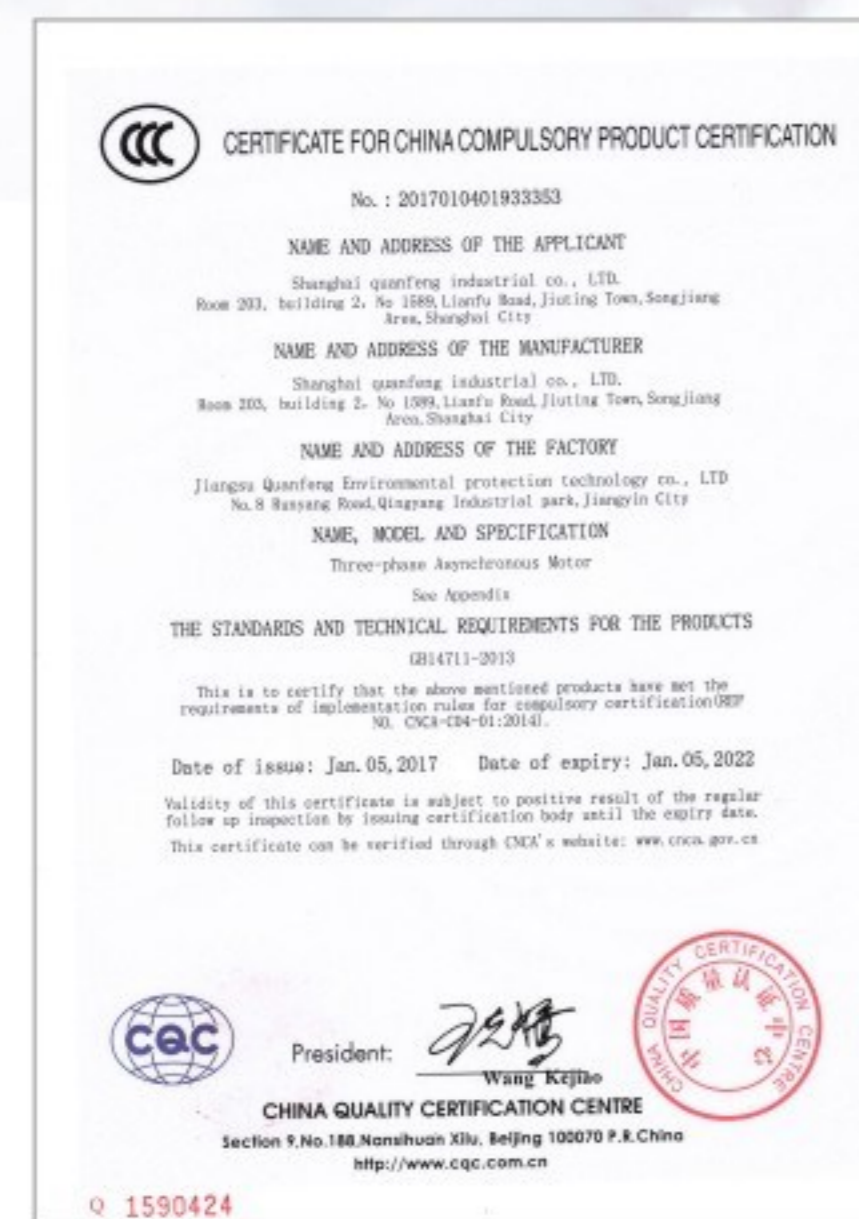
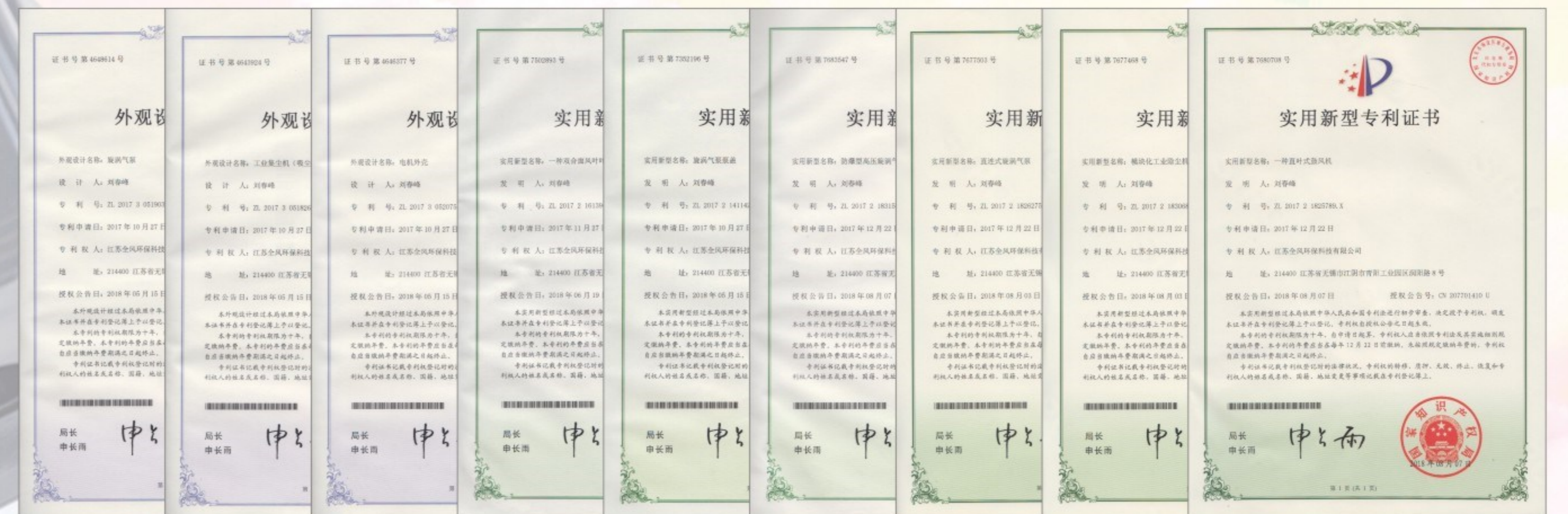

# PRODUCTION EQUIPMENT 生产设备



全风从产品设计、零件加工到整机装配、性能测试，每一台设备的下线，无不得益于全风技术与经验的积累，得益于全风员工精湛的技艺。也是全风在设备，基础设施和人员方面空前投入的结晶。

From product design, parts processing to whole machine assembly, performance testing, each equipment offline, all benefit from the accumulation of quanfeng technology and experience, benefit from the excellent skills of quanfeng employees. It is also the result of unprecedented investment in equipment, infrastructure and personnel.



PRODUCTION EQUIPMENT  
生产设备



研发、制造、设计、加工为一体的企业

# PRODUCTION EQUIPMENT 生产设备

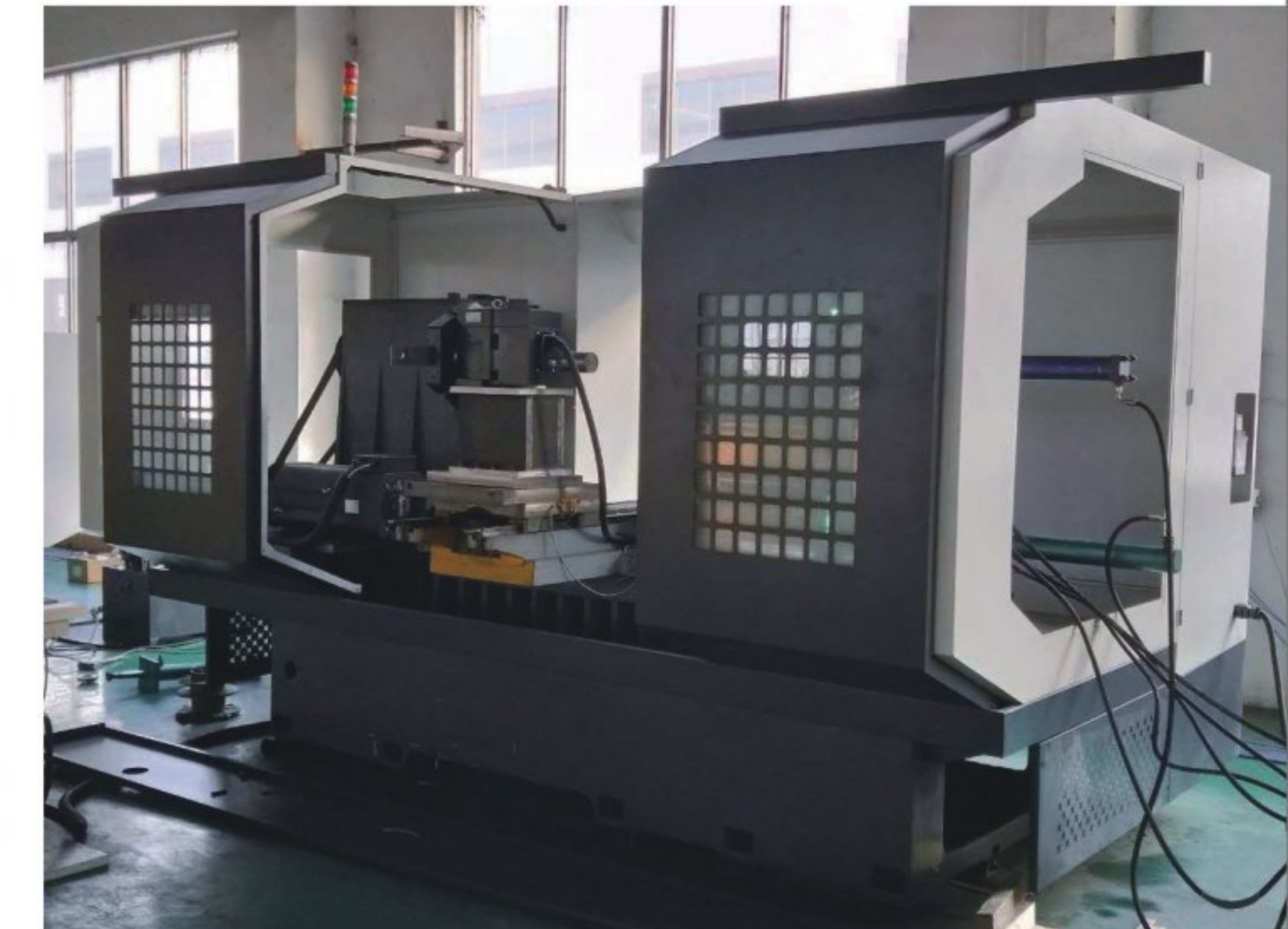
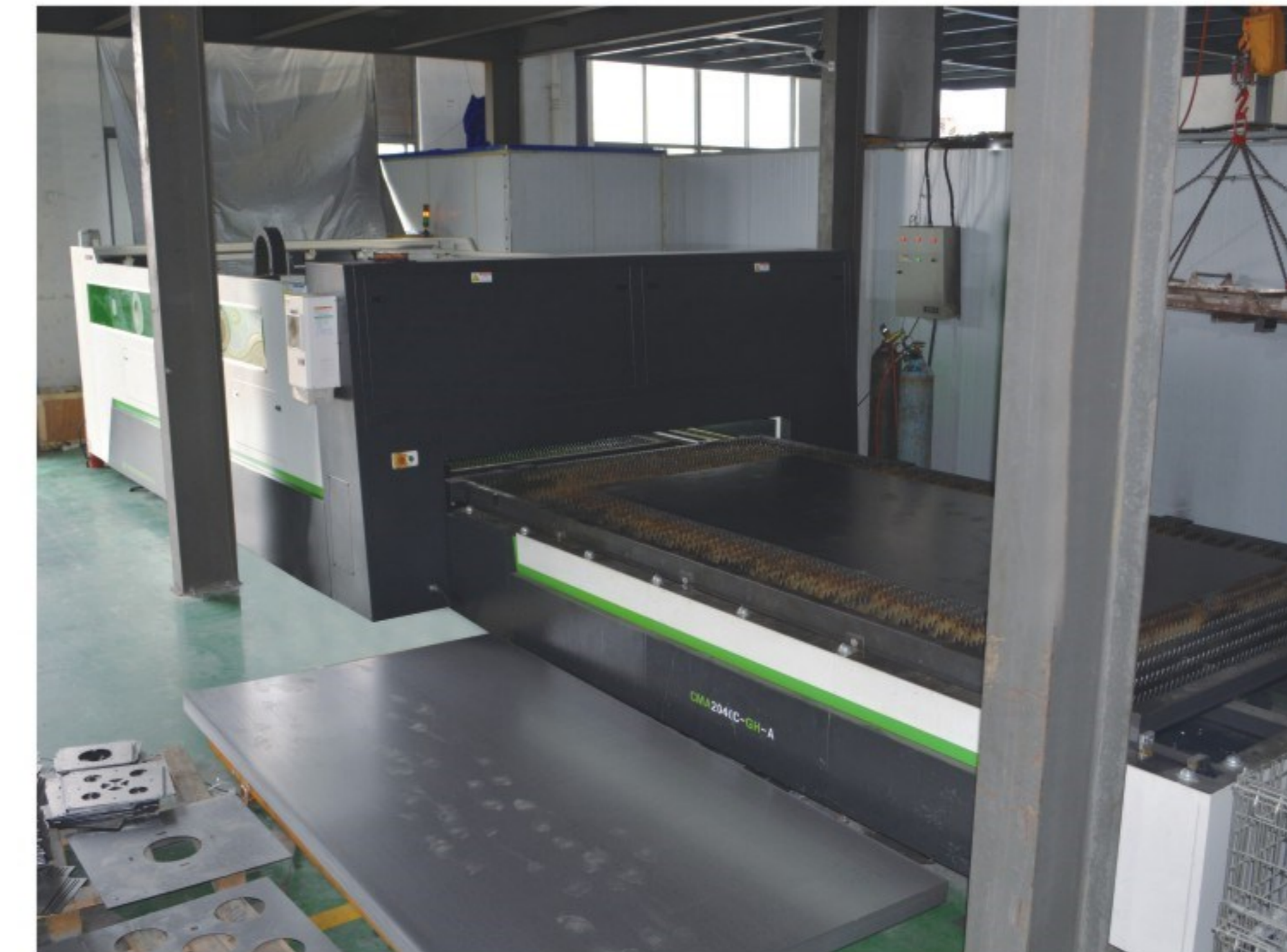
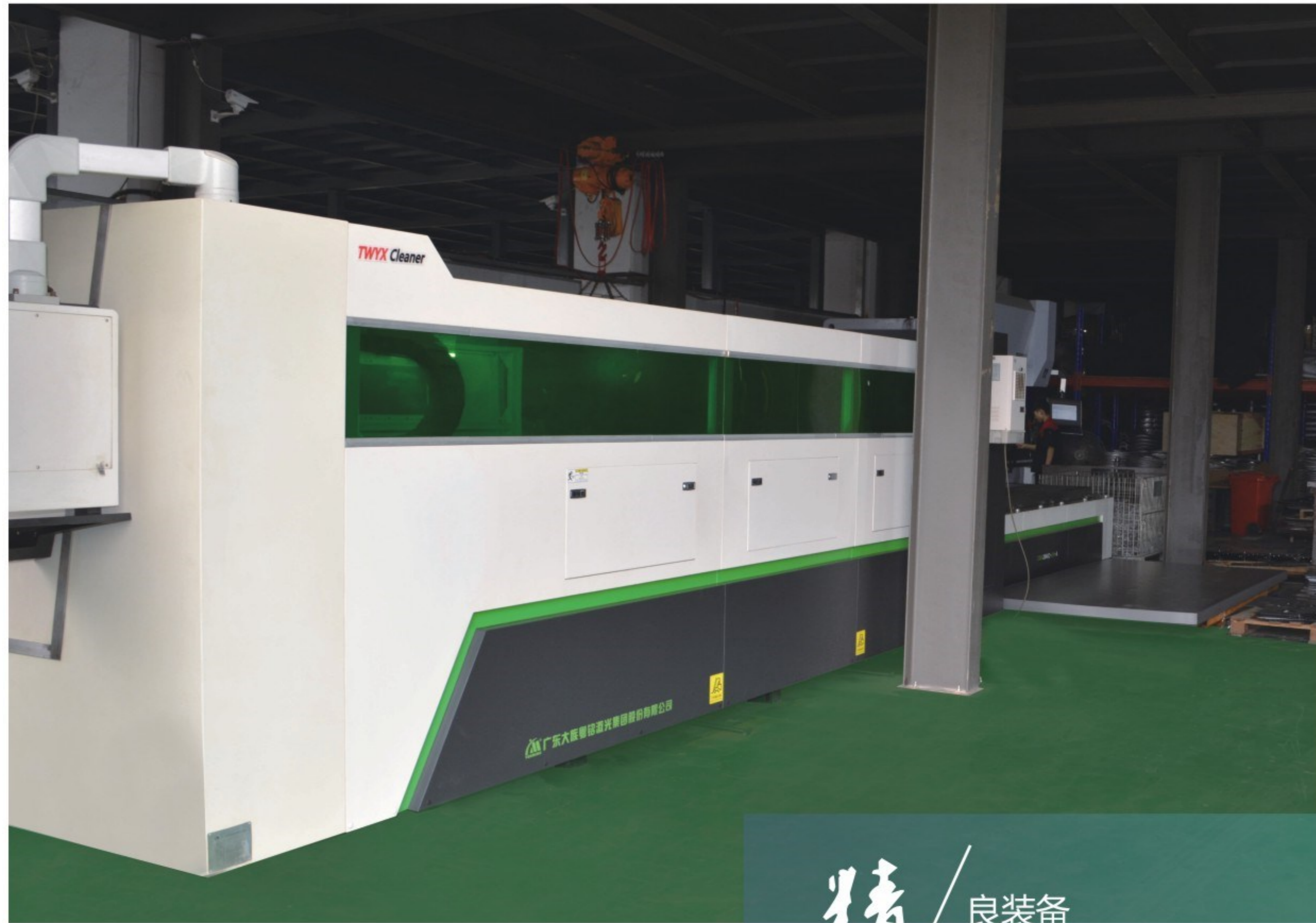

精 / 良装备  
SUPERIOR EQUIPMENT



# MCJC系列

## 工业脉冲集尘机

Industrial pulse dust collector



### 使用场所

五金、机械、汽车、电子、食品、化工、医药等行业除尘设备配套使用



### 概述 Summary

MC系列脉冲集尘机是我公司生产的实用新型专利产品，具有结构简单、修理养护方便、移动操作灵活、工作稳定可靠等显著性能优点，是一款性价比高、外观优美的理想环保设备。坚持安全、经济、适用，并兼顾美观的精心设计原则选择工艺优良成熟、系统稳定安全可靠、管理方便、无二次污染的治理技术；对设备、仪表等选型本着可靠、经济、适用的原则。

MC Series Pulse Dust Collector is a new type of patent product produced by our company. It has the advantages of simple structure, convenient repair and maintenance, flexible operation, stable and reliable operation. It is an ideal environmental protection equipment with high cost performance and atmospheric appearance. Adhering to the principles of safety, economy and application, and taking into account the beauty of the fine design, we should select advanced and mature technology, stable and reliable system, convenient management, and no secondary pollution treatment technology; selecting equipment, instruments and other types in accordance with the principles of reliability, economy and application.

### 技术参数 Technical parameters

型号	MCJC-1500	MCJC-2200	MCJC-4000	MCJC-5500	MCJC-7500	MCJC-11	MCJC-15
电源(V/Hz)	380/50	380/50	380/50	380/50	380/50	380/50	380/50
功率(Kw)	1.5	2.2	4.0	5.5	7.5	11	15
处理风量(m <sup>3</sup> /h)	1200	1800	1800/2500	3100	3800	4800	6000
风压(Pa)	2000	2500	2500/3800	4000	4000	5000	5400
过滤筒数量(个)	2	2	2/4	4	4	4	4
过滤面积(m <sup>2</sup> )	10	10	10/20	20	20	20	20
过滤精度(μm)	0.3-1	0.3-1	0.3-1	0.3-1	0.3-1	0.3-1	0.3-1
过滤效率	99%	99%	99%	99%	99%	99%	99%
过滤材质	聚酯纤维 PTFE 覆膜	聚酯纤维 PTFE 覆膜	聚酯纤维 PTFE 覆膜	聚酯纤维 PTFE 覆膜	聚酯纤维 PTFE 覆膜	聚酯纤维 PTFE 覆膜	聚酯纤维 PTFE 覆膜
压缩空气压力(Mpa)	0.4-0.6	0.4-0.6	0.4-0.6	0.4-0.6	0.4-0.6	0.4-0.6	0.4-0.6
压缩空气气缸(L/个)	8	8	8	15	15	15	15
集成箱容量(L)	80	80	80/120	120	120	200	200
噪音等级(dB)	60±2	65±2	70±2	75±2	78±2	80	80
过滤方式	负压外滤式	负压外滤式	负压外滤式	负压外滤式	负压外滤式	负压外滤式	负压外滤式
清灰方式	脉冲反吹+抽屜集尘	脉冲反吹+抽屜集尘	脉冲反吹+抽屜集尘	脉冲反吹+抽屜集尘	脉冲反吹+抽屜集尘	脉冲反吹+抽屜集尘	脉冲反吹+抽屜集尘
进风口口径(mm)	φ100-150	φ100-150	φ125	φ150/φ200	φ150	φ200*2	φ200*2
排风口口径(mm)	φ100	φ125	φ125	φ150	φ150	φ200	φ200
外形尺寸(mm)	600×630×1580	600×630×1580	600×630×1580 800×830×2030	800×830×2030	800×830×2030	1000×1030×2080	1000×1030×2080
航空空插头(m)	4(4芯)	4(4芯)	4(4芯)	4(4芯)	4(4芯)	4(4芯)	4(4芯)
重量(kg)	132	140	152/226	254	256	357	375
可移动性	工业万向脚轮(带刹车)			工业万向脚轮(带刹车),带叉车底角			
防护等级	IP55	IP55	IP55	IP55	IP55	IP55	IP55
机器外观喷漆	碳钢2.0喷塑涂装 桔纹白						



# MCJC系列

## 工业脉冲集尘机

Industrial pulse dust collector



### 性能特点 Performance characteristics



动力采用，透浦式鼓风机，铝合金机身、吸力大、噪音低、振动小。  
Power, through Pu blower, aluminum alloy body, suction, low noise, small vibration.



脉冲反吹清灰系统，滤芯可通过清理重复使用，喷吹法多角度喷吹，清灰更彻底。  
In the pulsed back blowing system, the filter core can be reused through cleaning and repeated use.



过滤采用进口PTFE覆膜聚酯滤料，过滤效率达99%，表面光滑，易于反吹，配快速法兰接头，更换快捷。  
The filter is made of imported PTFE coated polyester filter material, which has a filtration efficiency of 99%.

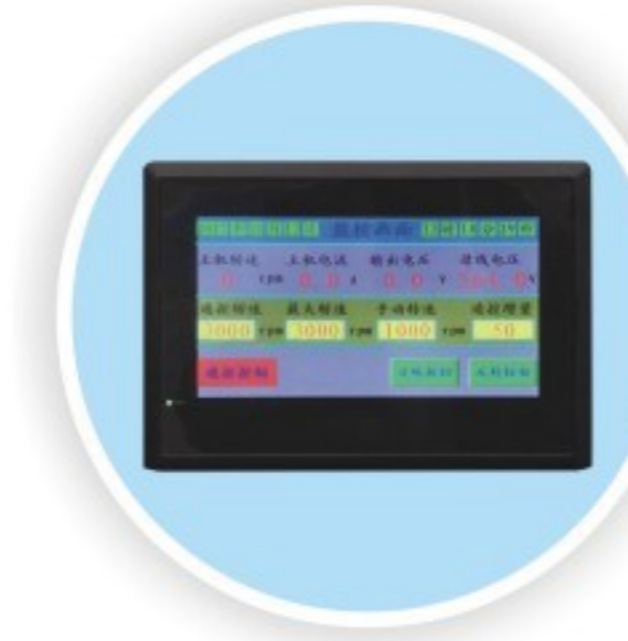

智能控制，可根据使用情况设定自动反吹清灰。  
Intelligent control, can be set according to the use of automatic reverse blowing.



预留LO接口，可与自动化设备联机进行远程操作。  
Reserve LO interfaces for remote operation online with automated devices.



缺相保护，超远距离遥控控制，大功率负载。  
Lack of phase protection, super remote control, high power load.

### 技术参数 Technical parameters

型号	MCJC-1500	MCJC-2200	MCJC-4000	MCJC-5500	MCJC-7500	MCJC-11	MCJC-15
外形尺寸 (mm)	600 × 630 × 1580	600 × 630 × 1580	600 × 630 × 1580 800 × 830 × 1880	800 × 830 × 1880	800 × 830 × 1880	1000 × 1030 × 1980	1000 × 1030 × 1980

# MCJC系列

## 工业脉冲集尘机

Industrial pulse dust collector



### 使用场所

五金、机械、汽车、电子、食品、化工、医药等行业除尘设备配套使用



MCJC-1500 MCJC-2200 MCJC-4000

### 设计原则 Design principles

1

坚持安全、经济、适用，并兼顾美观的精心设计原则；

Adhere to the principles of safety, economy, application and aesthetic design.

3

对设备、仪表等选型本着可靠、经济、适用的原则；

The selection of equipment and meters is based on the principle of reliability, economy and applicability.

2

精工细作，只为极致品质、系统稳定安全可靠、管理方便、无二次污染的治理技术；

Seiko meticulous work, only for the ultimate quality, system stability, safety and reliability, easy management, no secondary pollution control technology;

4

外观设计专利(ZL 2017 3 0518264.0)、实用新型专利(ZL 2017 2 1830689.6)、发明专利证书(CN108079679A)；

Appearance design patent (ZL 2017 3 0518 264.0), utility model patent (ZL 2017 22 1830689.6), invention patent certificate (CN108079679A);



### 使用场所

五金、机械、汽车、航空、  
电子、食品、化工、医药等  
各行业除尘、回收



### 概述 Summary

本系列产品主机采用透浦式中压风机、高压风机，具有结构简单、能耗低、噪音少、运作稳定、过滤效率高、清灰效果高、占用空间小、拆卸灰斗方便快捷、使用年限长、维护容易、移动操作灵活、工作稳定等显著性能优点，而且造价相当低廉，是理想的环保设备。

This series product host the transparent pu type medium pressure and high pressure fan fan, has simple structure, low energy consumption, less noise and stable operation, high filtration efficiency and effect, take up the space is little, convenient remove ash hopper, long service life, easy maintenance, mobile and other significant performance advantages of flexible operation, stable work, and relatively low cost, is the ideal environmental protection equipment.

### 性能特点 Performance characteristics



动力采用，透浦式鼓风机，铝合金机身、吸力大、噪音低、振动小。  
Power, through Pu blower, aluminum alloy body, suction, low noise, small vibration.



气缸式震动清灰系统，更换滤袋快捷方便。  
Cylinder vibration dust cleaning system, fast and convenient to replace the filter bag.



采用智能控制时间可调，清灰处理系统自动震动除尘。  
Adopt intelligent control time adjustable, dust cleaning system automatic vibration dust removal.



机械式压差表及控制面板。  
Mechanical differential pressure gauge and control panel.



大功率电源总开关。  
High power supply master switch.



缺相保护，超远距离遥控控制，大功率负载。  
Lack of phase protection, super remote control, high power load.



### 概述 Summary

集尘机含尘气体在中压风机的离心力作用下进入除尘器匀流室，进入匀流室后由于气流断面突然扩大及气流分布板作用，气流中一部分粗大颗粒在动和惯性力作用下直接沉降到灰斗；粒度细、密度小的尘粒进入各滤尘室后，通过布朗扩散和筛滤等组合效应，使粉尘沉降在滤芯表面上，净化后的气体进入净气室由排风管经风机排出。设备的阻力随着滤袋表面粉尘层厚度的增加而增大。阻力达到某一设定值时进行清灰。此时打开集尘器压缩空气开关以极短的时间通过压缩气缸，并在逆向气流冲刷的作用下，使气缸板产生上下振动，使附着在滤袋外表面上的粉尘被剥离落入灰斗中。

The dust containing gas of the dust collector enters the dust collector's uniform flow chamber under the action of the centrifugal force of the medium-pressure fan. After the fine particle size and small density enters each filter chamber, the dust precipitates on the surface of the filter core through combined effects such as brown diffusion and screen filtration, and the purified gas enters the clean air chamber and is discharged by the exhaust pipe through the fan. The resistance of the equipment increases with the increase of the thickness of the dust layer on the surface of the filter bag. Remove dust when resistance reaches a set value. At this time, open the dust collector compressed air switch to pass through the cylinder in a very short time, and under the action of reverse airflow scour, make the cylinder plate vibrate up and down, so that the dust attached on the outer surface of the filter bag is stripped and dropped into the ash hopper.

### 技术参数 Technical parameters

型号	JC-750-1	JC-1500-1	JC-1500L	JC-2200	JC-4000	JC-5500	JC-7500	JC-11	JC-15
电源(V/Hz)	220/380/50	220/380/50	380/50	380/50	380/50	380/50	380/50	380/50	380/50
功率(Kw)	0.75	1.5	1.5	2.2	4.0	5.5	7.5	11	15
处理风量(m³/h)	960	960	1200	1800	1800/2500	3100	3800	4800	6000
风压(Pa)	1900	2500	2000	2500	2500/3800	4000	4000	5000	5400
滤袋数量(个)	5	5	5	5	5	5	5	9	9
过滤面积(m²)	0.8	0.8	3	3	3	3	3	5	5
过滤精度(μm)	0.3-1	0.3-1	0.3-1	0.3-1	0.3-1	0.3-1	0.3-1	0.3-1	0.3-1
过滤效率	99%	99%	99%	99%	99%	99%	99%	99%	99%
过滤材质	过滤袋集尘	过滤袋集尘	过滤袋集尘	过滤袋集尘	过滤袋集尘	过滤袋集尘	过滤袋集尘	过滤袋集尘	过滤袋集尘
集成箱容量(L)	35	35	80	80	80/120	120	120	200	200
噪音等级(dB)	60±2	60±2	60±2	65±2	70±2	75±2	78±2	80	80
过滤方式	负压外滤式	负压外滤式	负压外滤式	负压外滤式	负压外滤式	负压外滤式	负压外滤式	负压外滤式	负压外滤式
清灰方式	气缸式振动除尘(选配)	气缸式振动除尘(选配)	气缸式振动除尘(选配)	气缸式振动除尘(选配)	气缸式振动除尘(选配)	气缸式振动除尘(选配)	气缸式振动除尘(选配)	气缸式振动除尘(选配)	气缸式振动除尘(选配)
进风口口径(mm)	φ100	φ100	φ100-150	φ100-150	φ125-150	φ150/φ200	φ150	φ200*2	φ200*2
排风口口径(mm)	φ100	φ100	φ100	φ125	φ125	φ150	φ150	φ200	φ200
外形尺寸(mm)	500×530×1055	500×530×1055	600×630×1580 700×730×1580	600×630×1580 700×730×1580	600×630×1580 700×730×1580 800×830×2080	800×830×2080	800×830×2080	1000×1030×2080	1000×1030×2080
航空插头(m)	4(4芯)	4(4芯)	4(4芯)	4(4芯)	4(4芯)	4(4芯)	4(4芯)	4(4芯)	4(4芯)
重量(kg)	76	80	110/132	118/132	130/152/200	228	280	355	372
可移动性	工业万向脚轮(带刹车)	工业万向脚轮(带刹车)							
防护等级	IP55	IP55	IP55	IP55	IP55	IP55	IP55	IP55	IP55
机器外观喷漆									

碳钢2.0喷塑涂装 桔纹白

# SH系列

## 重型工业移动吸尘器

Heavy industrial mobile vacuum cleaner



### 使用场所

五金、机械、汽车、电子、  
食品、化工、医药等行业除  
尘设备配套使用

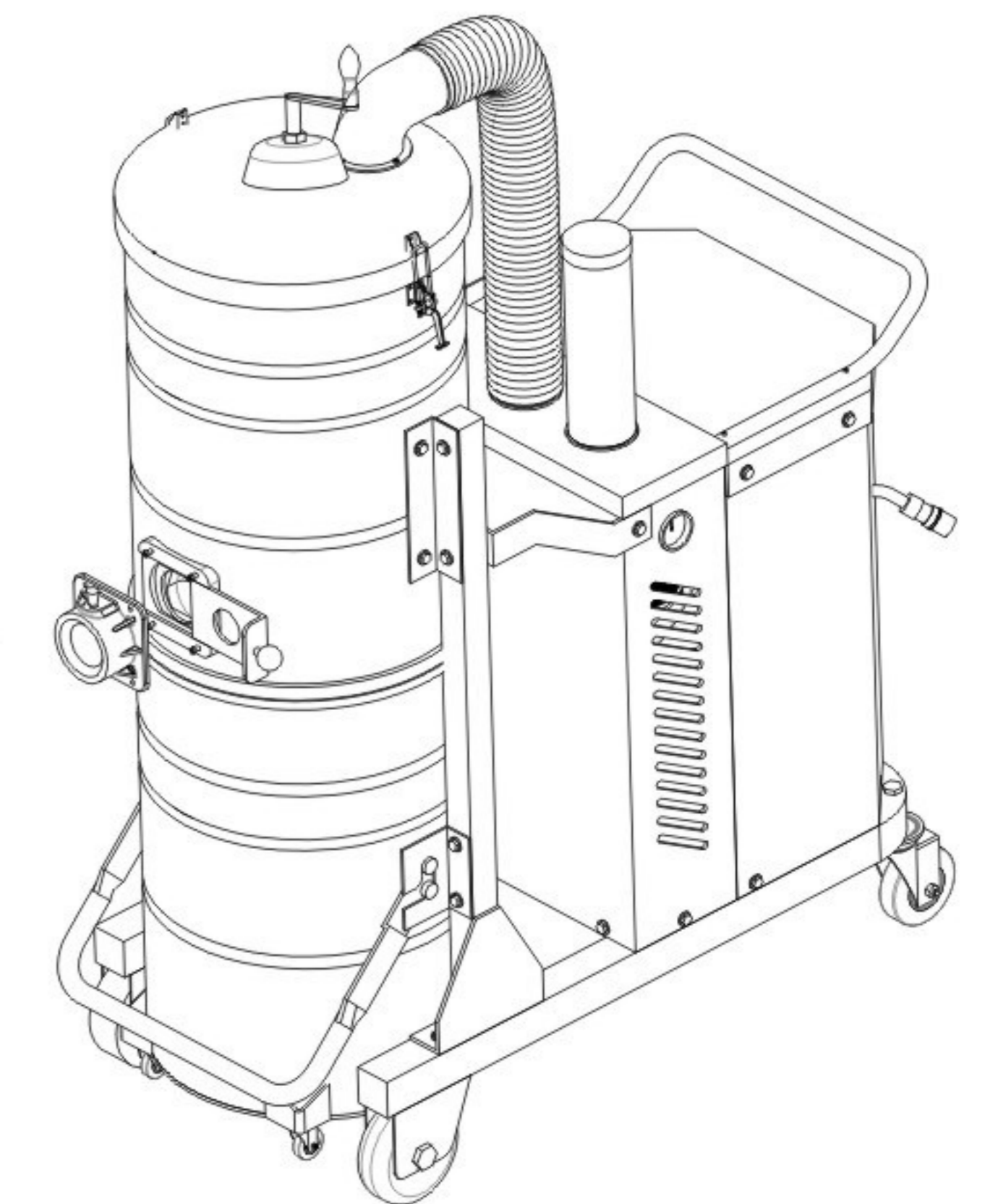

### 技术参数 Technical parameters

型号 Model	尘桶容量 Volume (L)	电压 Voltage (V)	功率 Power (KW)	吸力 Max. Vacuum (kPa)	风量 Airflow (m <sup>3</sup> /h)	噪音 Noise (dB)	重量 Weight (kg)	过滤面积 Filter area (m <sup>2</sup> )	吸尘口径 Suction caliber (mm)	尺寸 Dimensions L × W × H(mm)
SH2200	100	220/380-480	2.2	21	320	69	97	3.0	φ 50	1100 × 600 × 1500
SH3000	100	380-480	3.0	26	320	69	105	3.0	φ 50	1100 × 600 × 1500
SH4000	100	380-480	4.0	26	420	73	109	3.0	φ 50	1100 × 600 × 1500
SH5500	100	380-480	5.5	30	530	80	132	3.0	φ 50	1100 × 600 × 1500
SH7500	100	380-480	7.5	32	530	80	134	3.0	φ 50	1100 × 600 × 1500

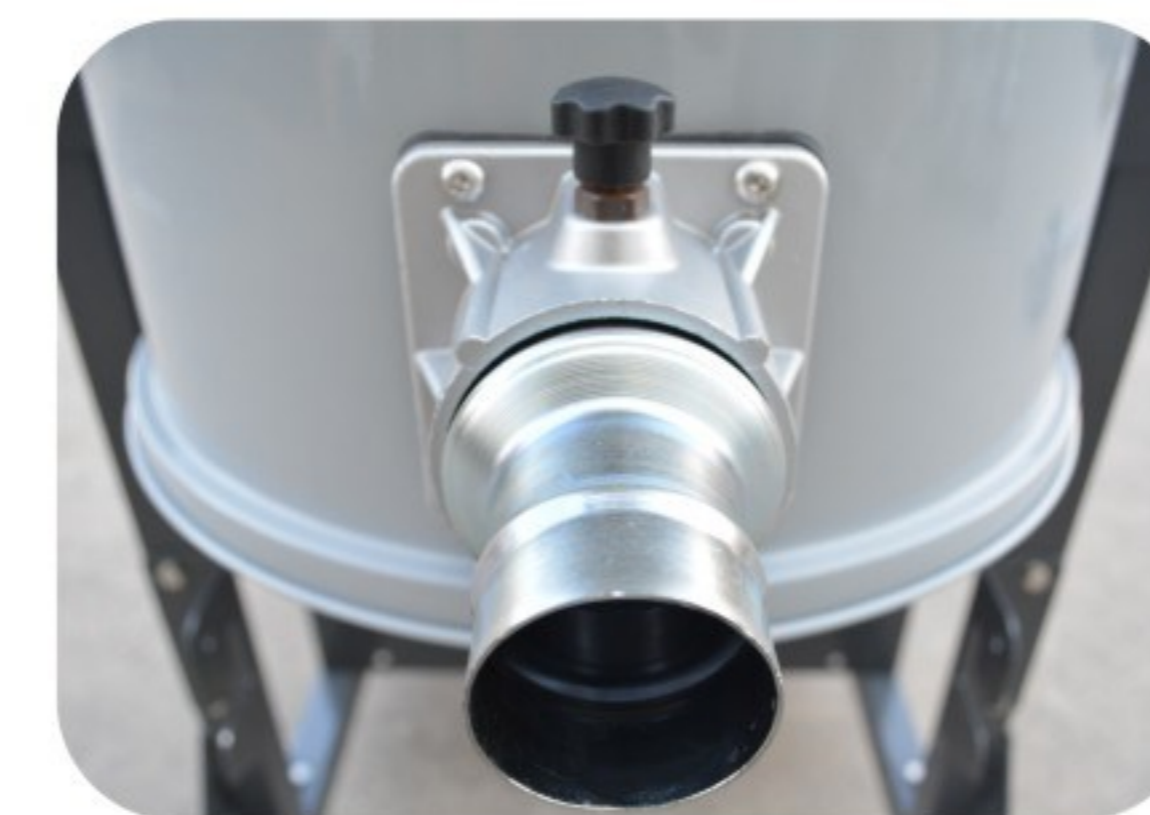
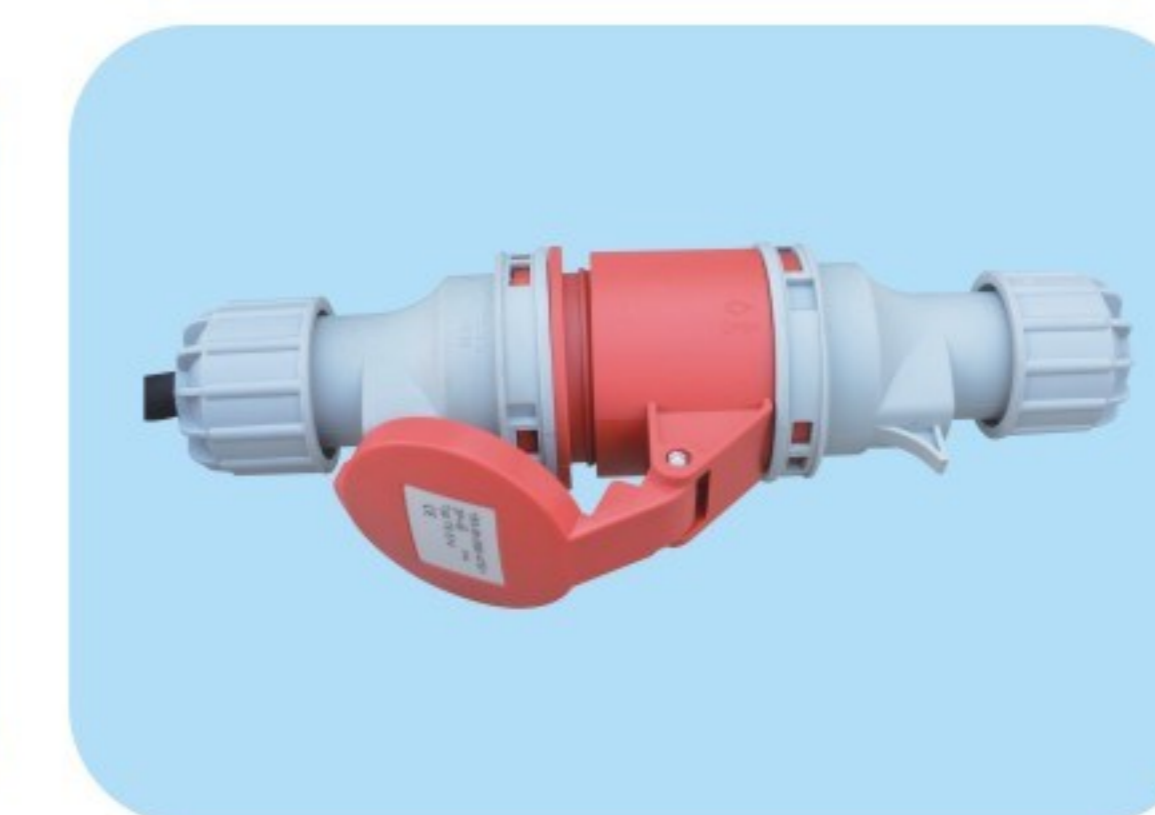

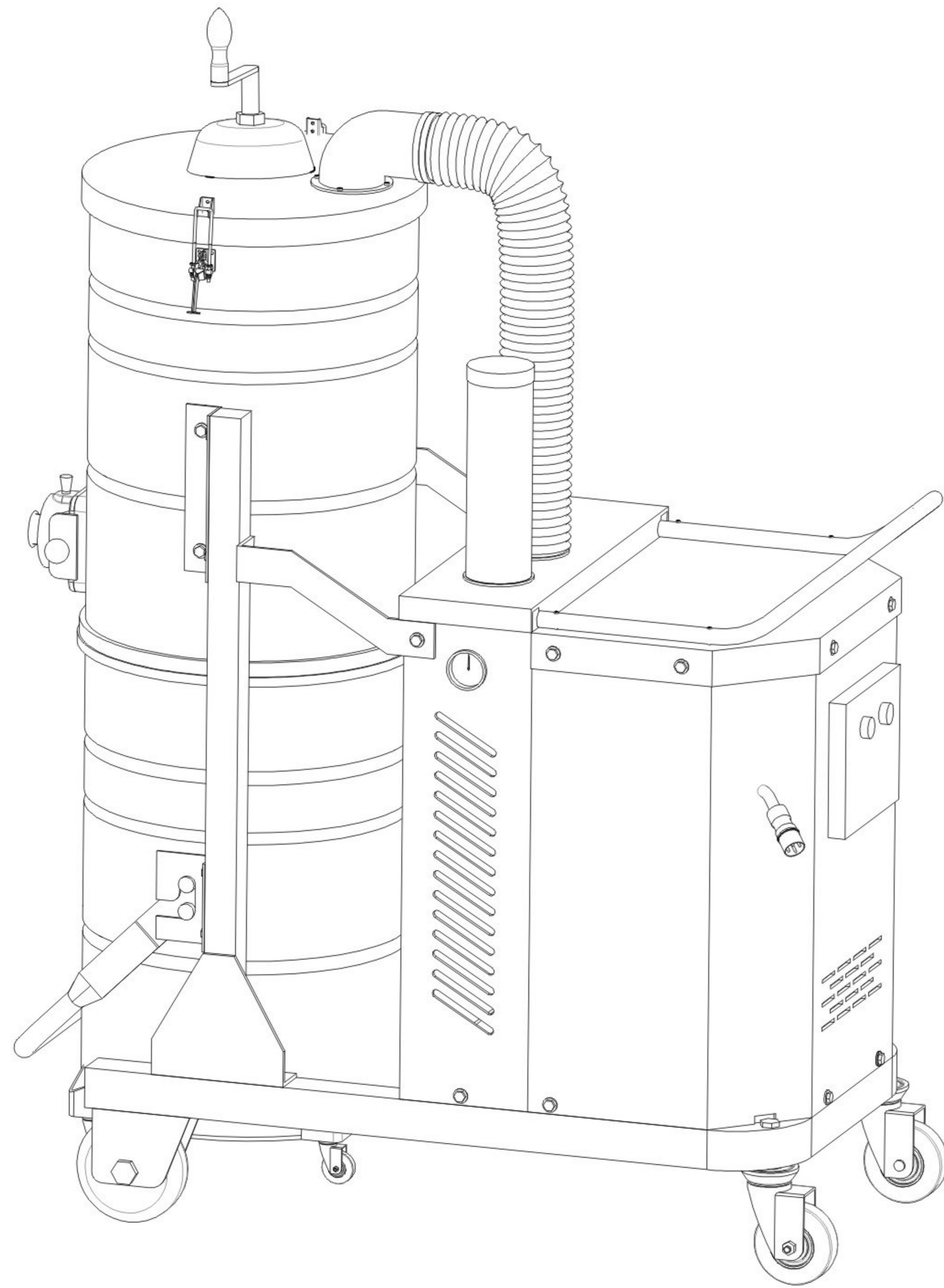

### 概述 Summary

SH系列是一种重型工业移动吸尘器，功率从0.75~7.5kw，广泛使用于制药、化工、陶瓷、机械、食品等行业。

SH series is a heavy industrial mobile vacuum cleaner with power from 0.75~7.5kw, widely used in pharmaceutical, chemical, ceramic, machinery, food and other industries.

### 性能特点 Performance characteristics

- 采用工业级旋涡气泵，欧标电机50HZ 60HZ 双频设计；
  - 配有大轮子，便于机身移动；
  - 可以连续24小时工作；
  - 高密度覆膜过滤器，过滤精度高达0.3微米；
  - 120L容量，更便捷的自卸分离桶；
  - 配有旋风分离器；分离效率为97%；
  - 采用全自动脉冲反清灰装置；
  - 带有过载、过流、装置及远程启动系统；
- The European standard motor 50HZ 60HZ dual-frequency design is adopted in Europe. Is equipped with extra large wheels, easy to move the body;
  - Positive can work 24 hours in a row;
  - High density mulch filter with filtration accuracy up to 0.3 micron;
  - 120L capacity, more convenient self-discharging separating barrel;
  - Plus cyclone separator;
  - The separation efficiency was 97%.
  - The full-automatic pulse back cleaning device is used in the high pressure area.
  - The tank is equipped with overload, overcurrent, device and remote start system;

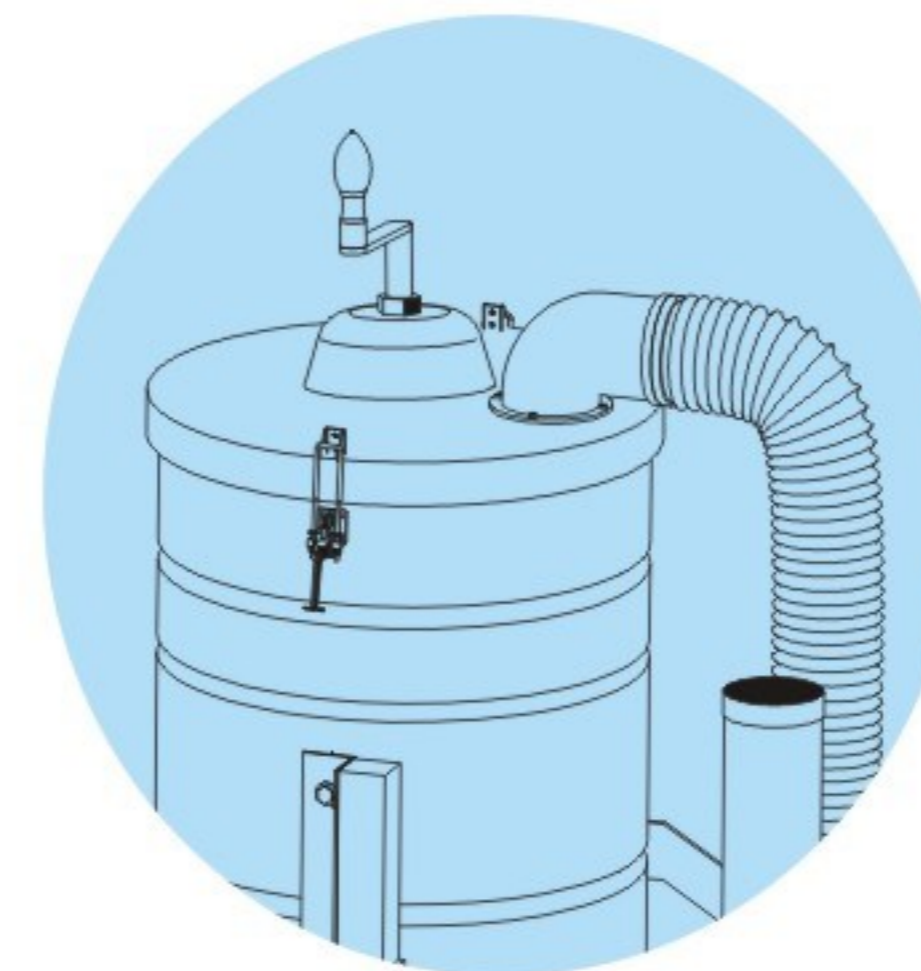

手摇拨片除尘(SYBP)  
Hand picking dust removal (SYBP)



自动脉冲反吹除尘(MCFC)  
Automatic pulse back blow dusting (MCFC)



手压反吹除尘(SDFC)  
Hand pressure reverse blowing dust removal (SDFC)



旋风分离除尘+超声波震动除尘(ZDCX)  
Cyclone separation dust removal  
+ ultrasonic vibration dedusting (ZDCX)



星形布袋除尘(BDCX)  
Star bag dust removal (BDCX)

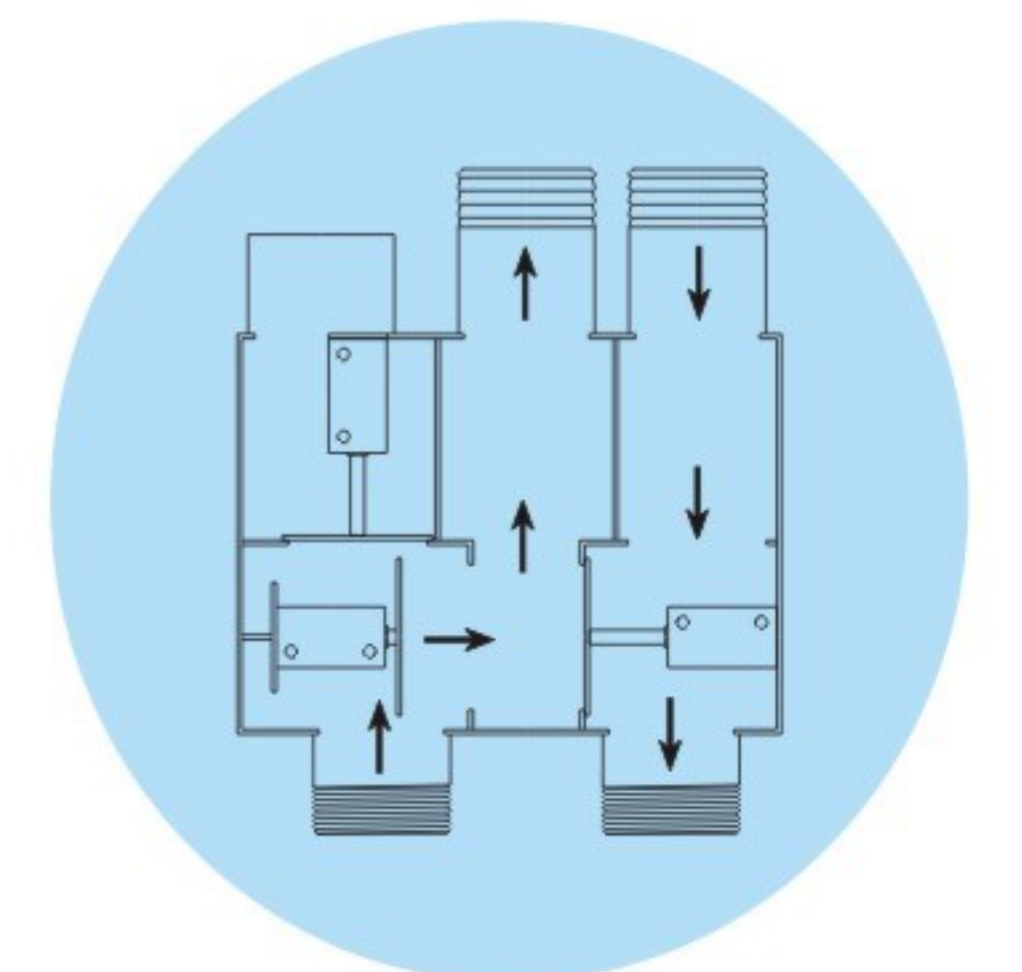

风泵自反吹装置除尘(ZFC)  
Air pump self blowing device dust removal (ZFC)

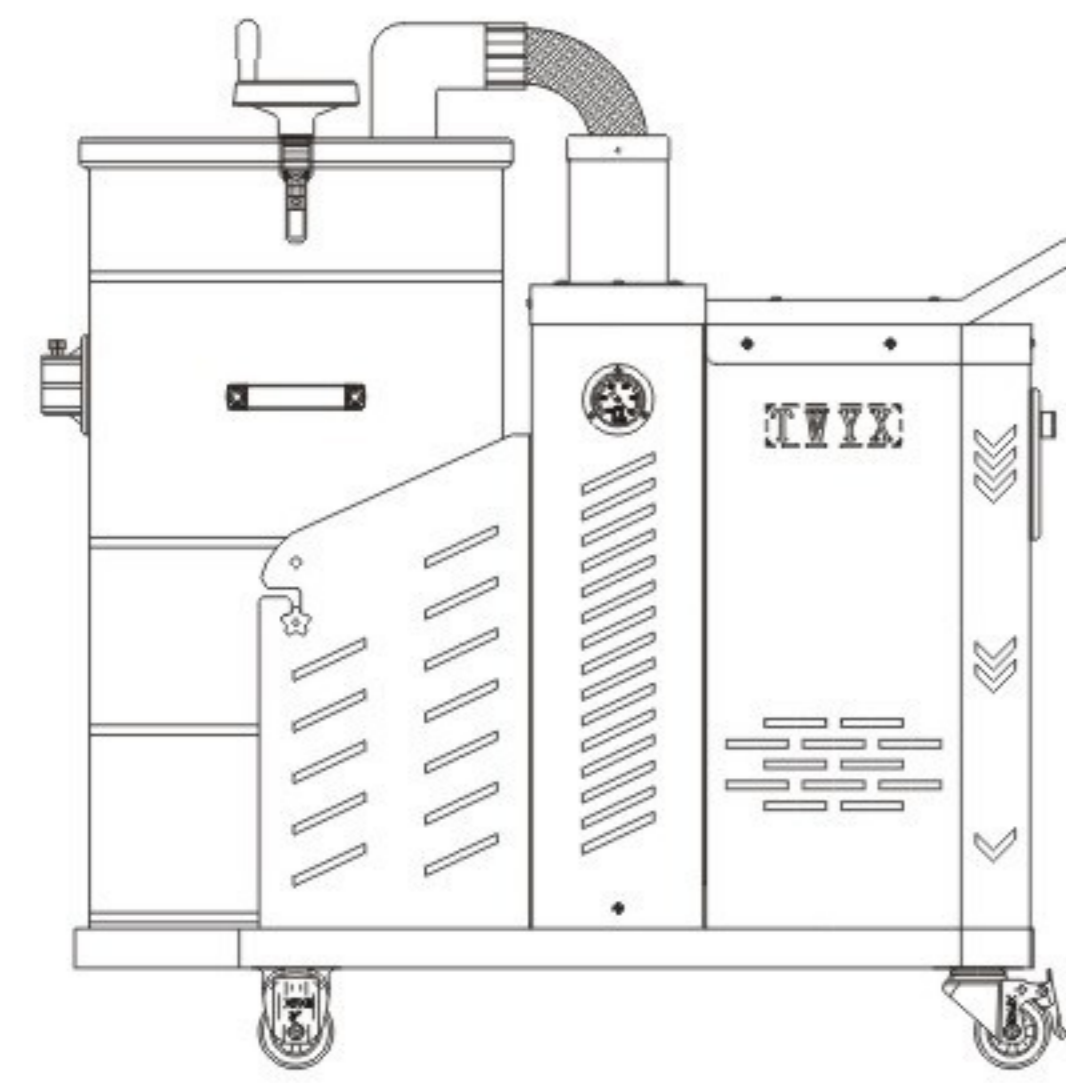

### 使用场所

小型工厂车间、吸铁屑、打磨粉尘、冶金、煤矿、设备配套等

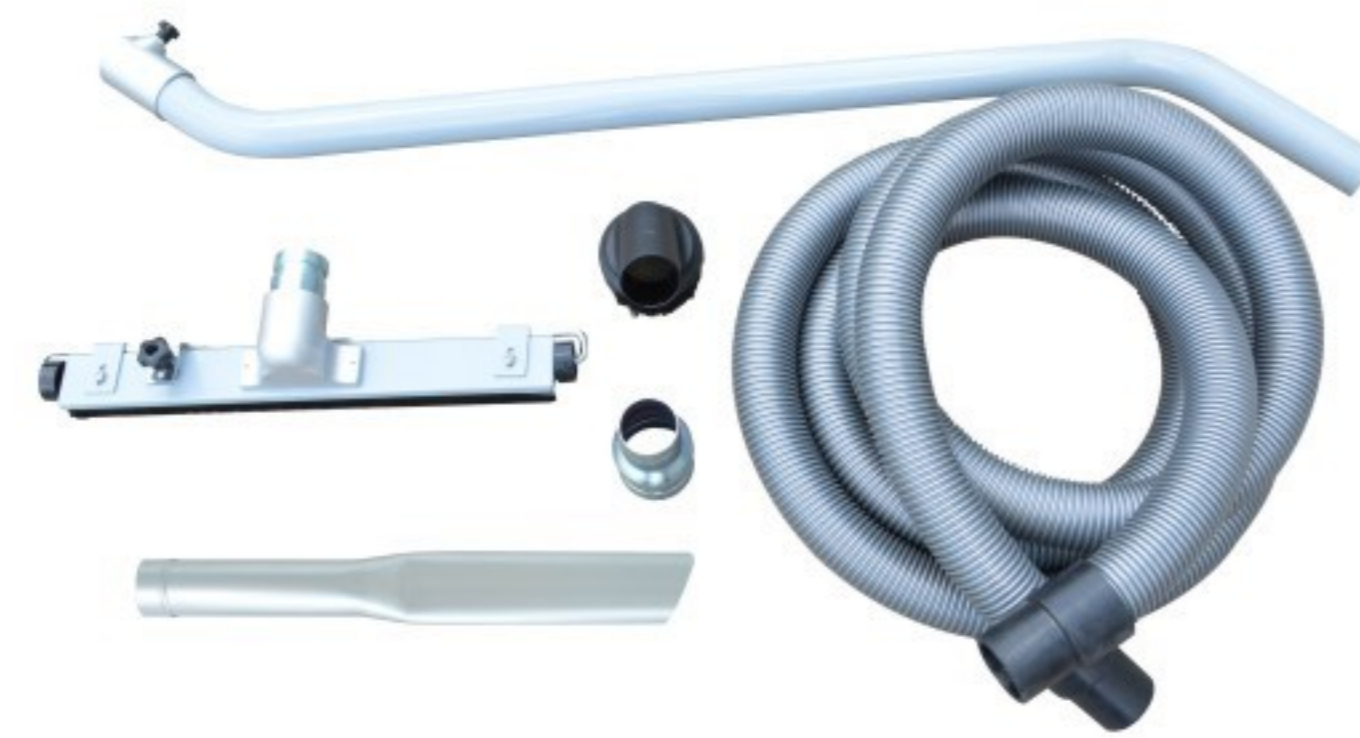

### 概述 Summary

DH系列是一种工业移动吸尘器，功率从1.5~4.0kw，广泛使用于小型工厂车间、吸铁屑、打磨粉尘、冶金、煤矿、设备配套等。

DH series is a kind of industrial vacuum cleaner with power ranging from 1.5 kW to 4.0 kw. It is widely used in small factory workshops, iron chips, grinding dust, metallurgy, coal mines, equipment matching and so on.

### 性能特点 Performance characteristics

- 采用工业级旋涡气泵，欧标电机50HZ 60HZ 双频设计；
  - 配有大型轮子，便于机身移动；
  - 可以连续24小时工作；
  - 高密度覆膜过滤器，过滤精度高达0.3微米；
  - 100L容量，更便捷的自卸分离桶；
  - 配有旋风分离器；分离效率为97%；
  - 采用全自动脉冲反清灰装置；
  - 带有过载、过流、装置及远程启动系统；
- The European standard motor 50HZ 60HZ dual-frequency design is adopted in Europe. Is equipped with extra large wheels, easy to move the body;
  - Positive can work 24 hours in a row;
  - High density mulch filter with filtration accuracy up to 0.3 micron;
  - 100L capacity, more convenient self-discharging separating barrel;
  - Plus cyclone separator;
  - The separation efficiency was 97%.
  - The full-automatic pulse back cleaning device is used in the high pressure area.
  - The tank is equipped with overload, overcurrent, device and remote start system;

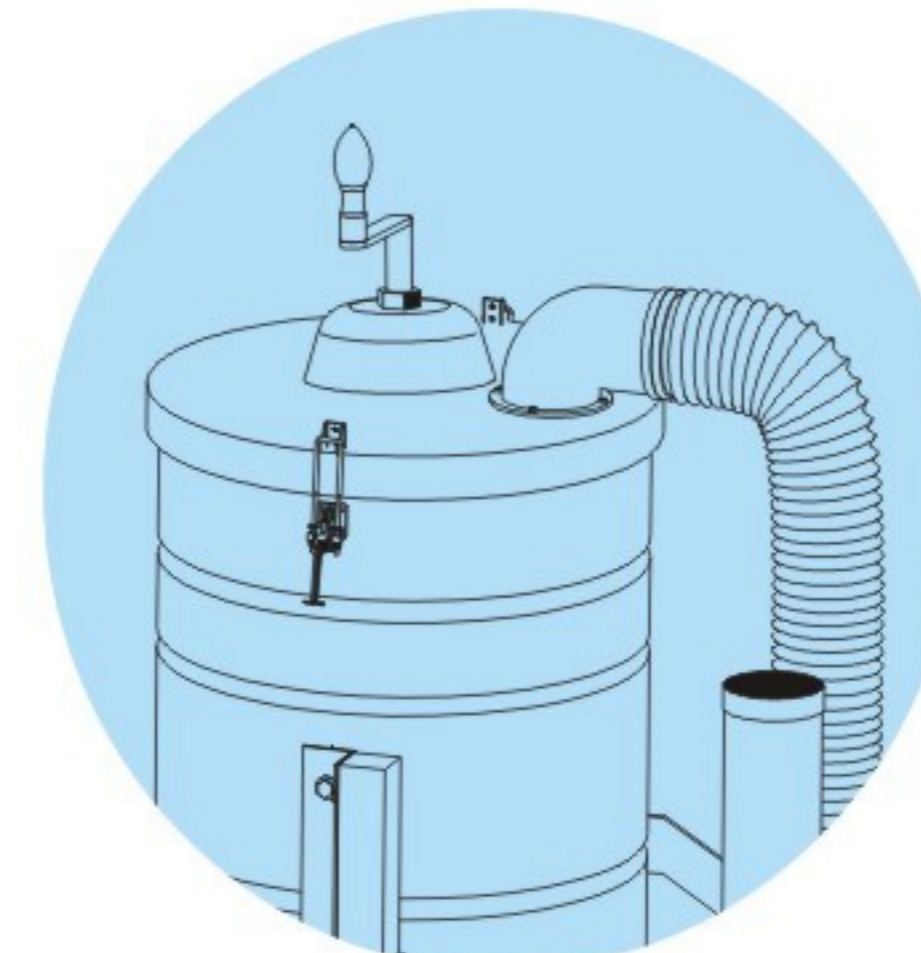

手摇拨片除尘(SYBP)  
Hand picking dust removal (SYBP)



自动脉冲反吹除尘(MCFC)  
Automatic pulse back blow dusting (MCFC)



手压反吹除尘(SDFC)  
Hand pressure reverse blowing dust removal (SDFC)



旋风分离除尘+超声波震动除尘(ZDCX)  
Cyclone separation dust removal + ultrasonic vibration dedusting (ZDCX)



星形布袋除尘(BDCX)  
Star bag dust removal (BDCX)

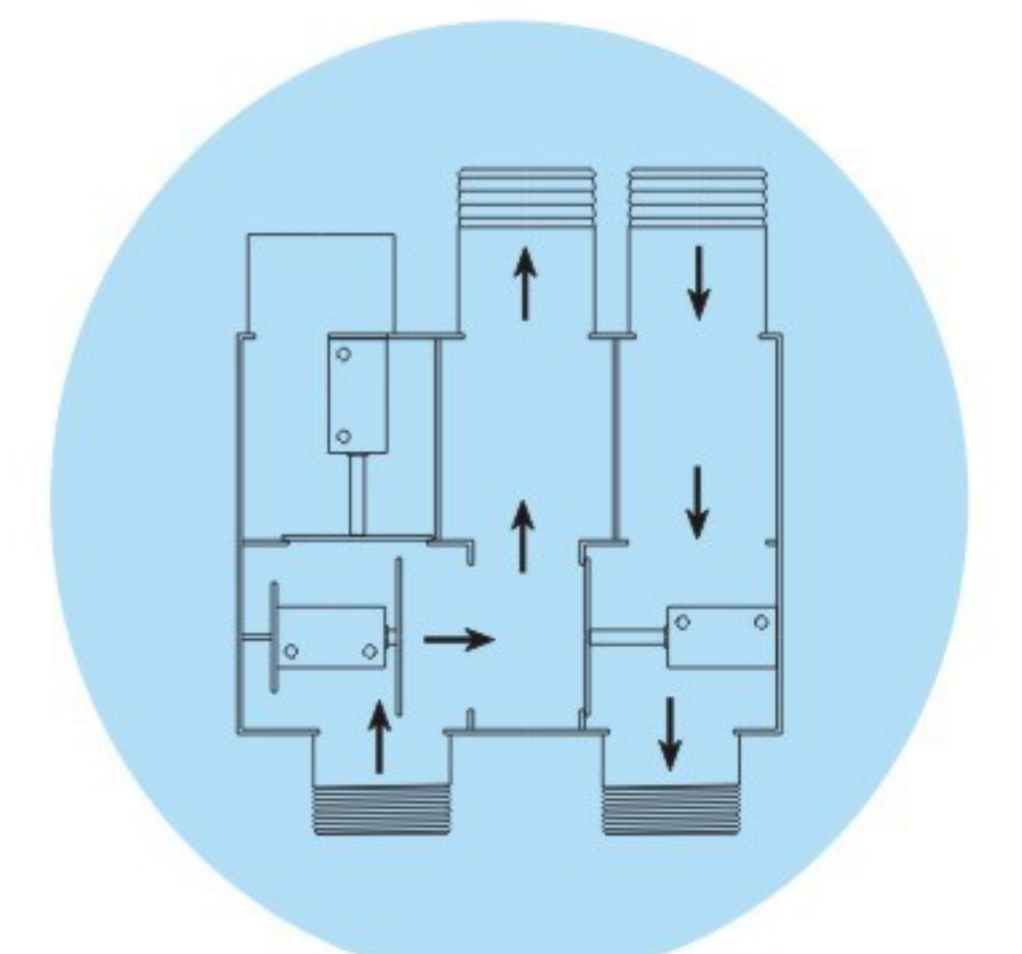

风泵自反吹装置除尘(ZFC)  
Air pump self blowing device dust removal (ZFC)

### 技术参数 Technical parameters

型号 Model	尘桶容量 Volume (L)	电压 Voltage (V)	功率 Power (KW)	吸力 Max. Vacuum (kPa)	风量 Airflow (m <sup>3</sup> /h)	噪音 Noise (dB)	重量 Weight (kg)	过滤面积 Filter area (m <sup>2</sup> )	吸尘口径 Suction caliber (mm)	尺寸 Dimensions L × W × H (mm)
DH1500	100	220/380-480	1.5	18	320	69	66	3.0	φ 50	1060 × 465 × 1050
DH2200	100	220/380-480	2.2	21	320	69	72	3.0	φ 50	1060 × 465 × 1050
DH3000	100	380-480	3.0	27	420	69	80	3.0	φ 50	1060 × 465 × 1050
DH4000	100	380-480	4.0	29	420	69	84	3.0	φ 50	1060 × 465 × 1050



### 使用场所

小型工厂车间、吸铁屑、打磨粉尘、冶金、煤矿、设备配套等



30L 小型工业移动吸尘器



80L 工业移动吸尘器

### 概述 Summary

DL系列是一种工业移动吸尘器，功率从0.75~4.0kw，广泛使用于小型工厂车间、吸铁屑、打磨粉尘、冶金、煤矿、设备配套等。

DL series is a kind of industrial vacuum cleaner with power ranging from 0.75 kW to 4.0 kW. It is widely used in small factory workshops, iron chips, grinding dust, metallurgy, coal mines, equipment matching and so on.

### 性能特点 Performance characteristics

- 采用工业级旋涡气泵，欧标电机50HZ 60HZ 双频设计；
  - 配有大型轮子，便于机身移动；
  - 可以连续24小时工作；
  - 高密度覆膜过滤器，过滤精度高达0.3微米；
  - 100L容量，更便捷的自卸分离桶；
  - 配有旋风分离器；分离效率为97%；
  - 采用全自动脉冲反清灰装置；
  - 带有过载、过流、装置及远程启动系统；
- The European standard motor 50HZ 60HZ dual-frequency design is adopted in Europe. Is equipped with extra large wheels, easy to move the body;
  - Positive can work 24 hours in a row;
  - High density mulch filter with filtration accuracy up to 0.3 micron;
  - 100L capacity, more convenient self-discharging separating barrel;
  - Plus cyclone separator;
  - The separation efficiency was 97%.
  - The full-automatic pulse back cleaning device is used in the high pressure area.
  - The tank is equipped with overload, overcurrent, device and remote start system;

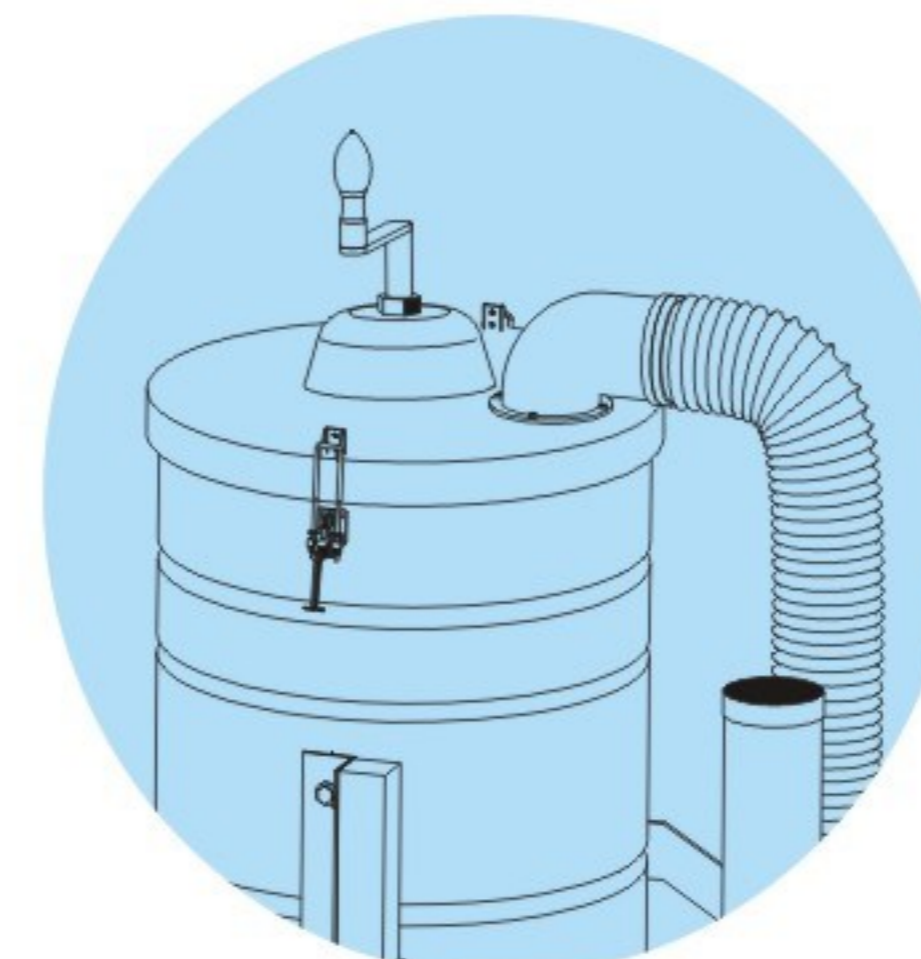

手摇拨片除尘(SYBP)  
Hand picking dust removal (SYBP)



自动脉冲反吹除尘(MCFC)  
Automatic pulse back blow dusting (MCFC)



手压反吹除尘(SDFC)  
Hand pressure reverse blowing dust removal (SDFC)



旋风分离除尘+超声波震动除尘(ZDCX)  
Cyclone separation dust removal + ultrasonic vibration dedusting (ZDCX)



星形布袋除尘(BDCX)  
Star bag dust removal (BDCX)

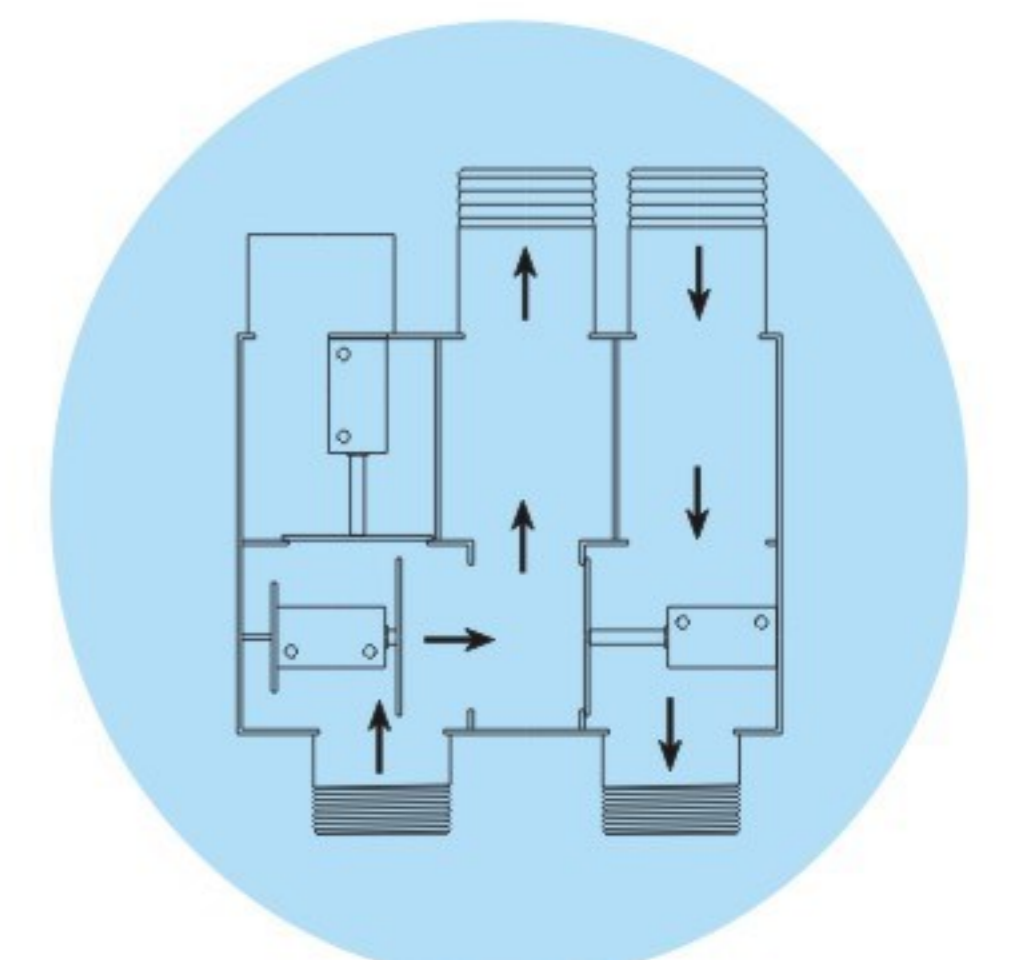

风泵自反吹装置除尘(ZFC)  
Air pump self blowing device dust removal (ZFC)

### 技术参数 Technical parameters

型号 Model	尘桶容量 Volume (L)	电压 Voltage (V)	功率 Power (KW)	吸力 Max. Vacuum (kPa)	风量 Airflow (m <sup>3</sup> /h)	噪音 Noise (dB)	重量 Weight (kg)	过滤面积 Filter area (m <sup>2</sup> )	吸尘口径 Suction caliber (mm)	尺寸 Dimensions L × W × H(mm)
DL750-30	30	220/380-480	0.75	12	145	64	47	2.0	φ 40	820 × 350 × 700
DL1100-30	30	220/380-480	1.1	17	210	69	49	2.0	φ 40	820 × 350 × 700
DL1500	30/80	220/380-480	1.5	18	320	69	53	3.0	φ 40	820 × 350 × 700
DL2200	80	220/380-480	2.2	21	320	69	82	3.0	φ 40	1020 × 460 × 980
DL3000	80	380-480	3.0	27	420	69	90	3.0	φ 40	1020 × 460 × 980
DL4000	80	380-480	4.0	29	420	69	94	3.0	φ 40	1020 × 460 × 980



### 使用场所

小型工厂车间、吸铁屑、打磨粉尘、冶金、煤矿、小型激光打标机及设备配套等



### 概述 Summary

GYJC系列是一种工业移动柜式吸尘器，功率从1.5~4.0kw，广泛使用于小型工厂车间、吸铁屑、打磨粉尘、冶金、煤矿、小型激光打标机及设备配套等。

GYJC series is a kind of industrial mobile cabinet vacuum cleaner with power ranging from 1.5 kW to 4.0 kw. It is widely used in small factory workshops, iron chips, grinding dust, metallurgy, coal mines, small laser marking machines and equipment matching.

### 性能特点 Performance characteristics

- 采用工业级旋涡气泵，欧标电机50HZ 60HZ 双频设计；
  - 配有大型轮子，便于机身移动；
  - 可以连续24小时工作；
  - 高密度覆膜过滤器或布袋除尘；
  - 30L容量，抽屉式储存；
  - 带有大功率主电源开关；
- Adopt industrial grade vortex air pump, Euro standard motor 50HZ 60HZ dual frequency design;
  - Equipped with super large wheels to facilitate the movement of the fuselage;
  - You can work 24 hours in a row;
  - High precision membrane filter or cloth bag dust removal;
  - 30L large capacity, drawer type storage;
  - With high-power main power switch.

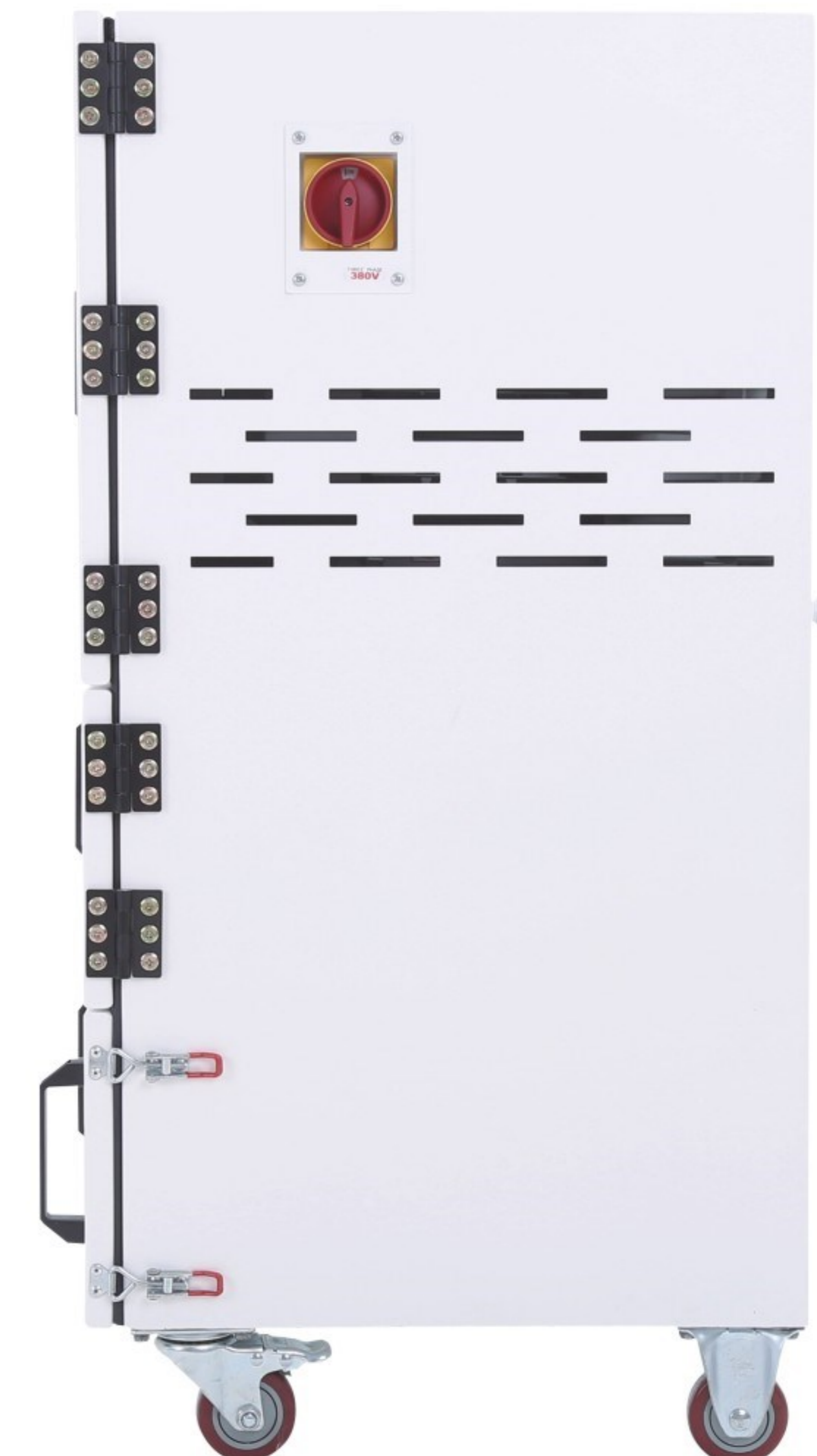

### 技术参数 Technical parameters

型号 Model	尘桶容量 Volume (L)	电压 Voltage (V)	功率 Power (KW)	吸力 Max. Vacuum (kPa)	风量 Airflow (m³/h)	噪音 Noise (dB)	重量 Weight (kg)	过滤面积 Filter area (m²)	吸尘口径 Suction caliber (mm)	尺寸 Dimensions L × W × H(mm)
GYJC1500	30	220/380-480	1.5	18	320	69	83	3.0	φ 50	500 × 530 × 1055
GYJC2200	30	220/380-480	2.2	21	320	69	89	3.0	φ 50	500 × 530 × 1055
GYJC3000	30	380-480	3.0	27	420	69	97	3.0	φ 50	500 × 530 × 1055
GYJC4000	30	380-480	4.0	29	420	69	101	3.0	φ 50	500 × 530 × 1055



### 使用场所

焊接、切割、打磨等工艺设计的高效净化器

### 概述 Summary

YC系列烟尘净化器，是一款专门针对焊接、切割、打磨等工艺设计的高效净化器，该系列净化器采用机械式过滤方式，并配置活性炭过滤层，对于颗粒细微的锡焊烟尘也有非常高的过滤效果，它净化效率高，轻巧灵活，并可配备不同长度的万向吸气臂，对于微米级的早烟过滤效率可达到99.9%，可极大的提高生产品质和改善工作环境。

YC Series Dust Purifier is a highly efficient purifier designed for welding, cutting, grinding and other processes. This series of purifiers adopts mechanical filtering method and is equipped with activated carbon filter layer. It also has very high filtering effect for fine solder welding dust. It has high purification efficiency, light and flexible, and can be equipped with. With different lengths of universal suction arms, the filtration efficiency of dry smoke in micron level can reach 99.9%, which can greatly improve the production quality and improve the working environment.

### 性能特点 Performance characteristics

- 轻巧灵活，操作方便；
  - 配有拉动伸缩自如可360度悬停的柔性吸气臂；
  - 采用PTEE覆膜高级滤桶式滤芯，过滤效果高，可达99.9%；
  - 可以加装活性炭过滤器，方便清除异味；
  - 可采用手动方式/自动脉冲反吹方式清理过滤尘隔；
  - 机身内有防火星飞溅装置；
- Light and flexible, easy to operate.
  - A flexible suction arm with 360 degrees of hovering for pulling freely and freely.
  - Adopt PTEE membrane coated advanced filter barrel core, and the filtration effect is high, up to 99.9%.
  - You can add activated carbon filter to remove odor easily.
  - It can be cleaned by manual / automatic pulse reverse blowing.
  - There are fireproof splash devices in the fuselage.

### 技术参数 Technical parameters

型号 Model	电压 Voltage (V)	风量 Airflow (m <sup>3</sup> /h)	过滤材料 Filter material	滤桶 数量	过滤 精度 (μm)	控制 部分	总过滤 面积 (m <sup>2</sup> )	噪音 Noise (dB)	清灰 方式	尺寸 Dimensions L × W × H(mm)	功率 Power (KW)	吸力 Max. Vacuum (kPa)
YC-22	380V	3000	聚酯纤维 覆膜	1	0.1	施耐德 电气	>10	>75±5	自动反吹	700×700×1600	2.2	2100
	50HZ	也可选配							全方位清灰	不含吸气臂	全风实业	中压风机
YC-30	380V	4000/ 也可选配	聚酯纤维 覆膜	1	0.2	施耐德 电气	>12	>78±5	自动反吹	700×700×1600	3	2500
	50HZ	也可选配							全方位清灰	不含吸气臂	全风实业	中压风机



柔性吸气臂  
Flexible suction arm



刚性吸气臂  
Rigid suction arm



螺旋型通风管道  
Spiral ventilation duct



吸气软管及吸口  
Suction hose and suction port



吸气罩组合  
Suction hood assembly



过滤筒  
Filter cartridge

## 中央烟尘净化/粉尘中央集尘

Central dust cleaning / dust centring dust collection

### 使用场所

专注于净化受焊接、切割、打磨等烟尘污染的工作环境及机械加工粉尘处理

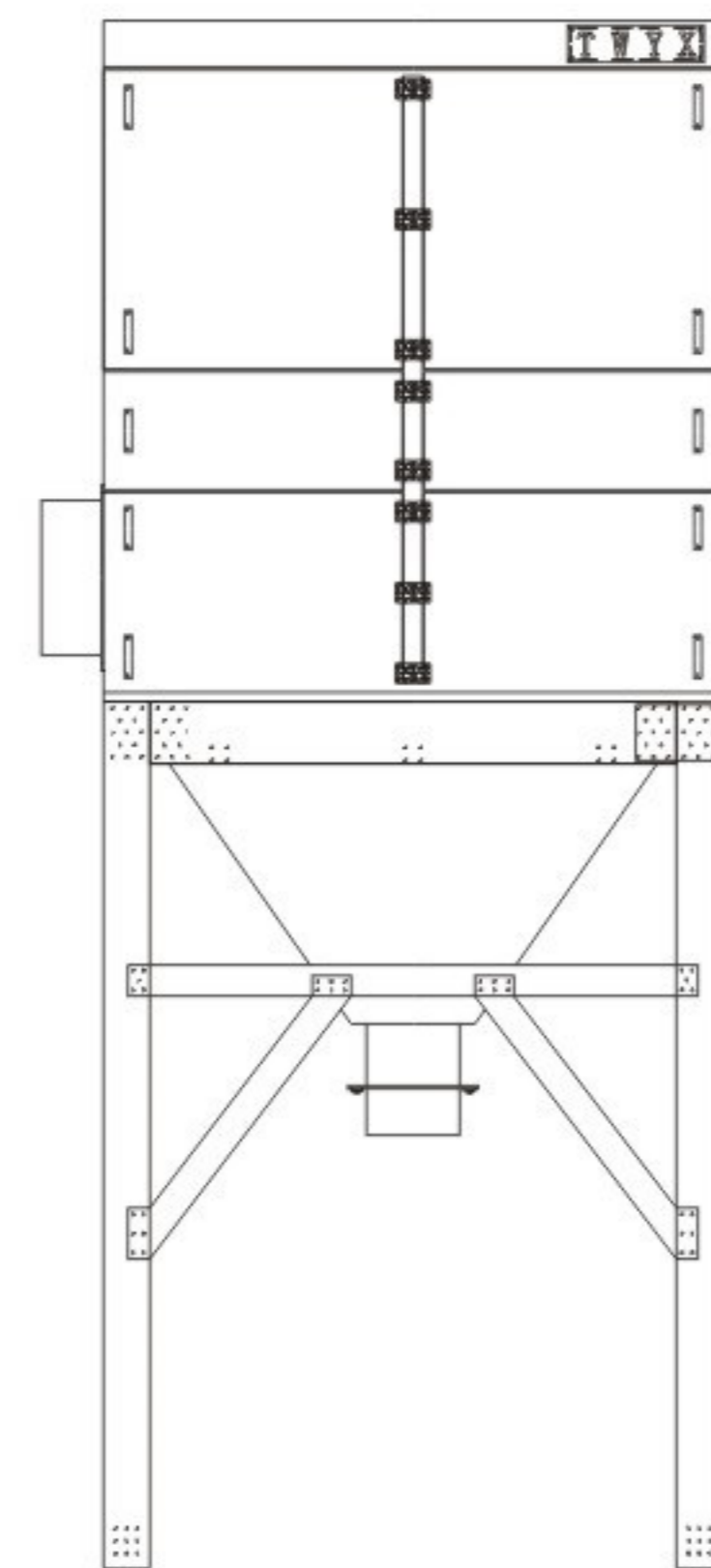

ZYJC-30000

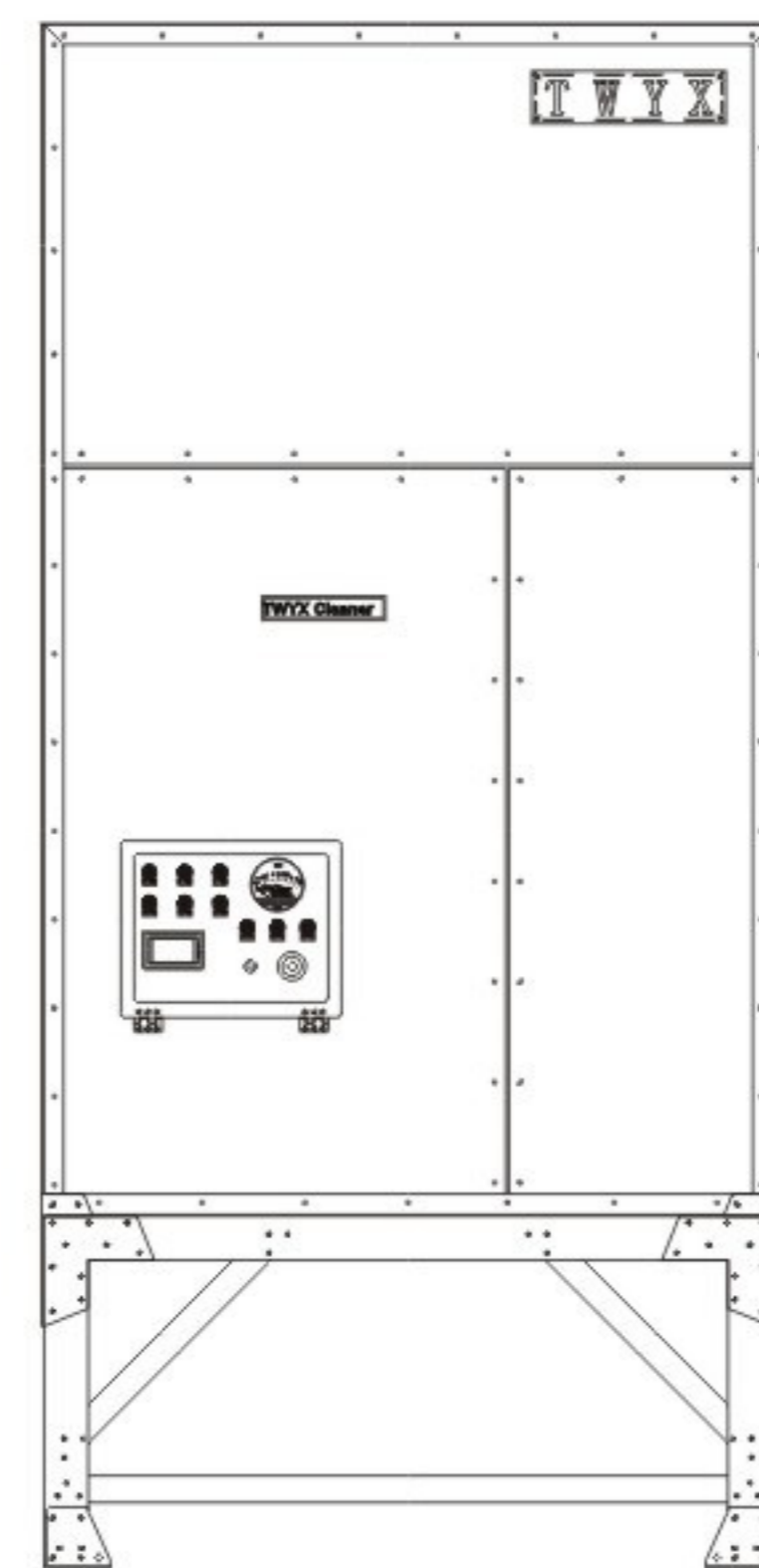

ZYJC-5500/ZYJC-15000

### 性能特点 Performance characteristics

- 平台有效切割宽度较大;
- 烟尘、粉尘捕捉率高;
- 粉尘清理方便;
- 一边吹一边吸效果更佳;
- Effective cutting width larger platform;
- Soot, dust capture rate;
- Easy to clean dust;
- While blowing suction side better;

### 技术参数 Technical parameters

型号	ZYJC-5500	ZYJC-7500	ZYJC-11000	ZYJC-15000	ZYJC-30000
电源(V/Hz)	380/50	380/50	380/50	380/50	380/50
功率(Kw)	5.5	7.5	11	15	30(双机组)
处理风量(m <sup>3</sup> /h)	3900	4000	4800	6000	12000
风压(Pa)	3800	3900	5000	5000	5000
过滤筒数量(个)	12	12	12	12	15
过滤面积(m <sup>2</sup> )	120	120	120	120	150
过滤精度(μm)	0.3-1	0.3-1	0.3-1	0.3-1	0.3-1
过滤效率	99%	99%	99%	99%	99%
过滤材质	聚酯纤维 PTFE 覆膜	聚酯纤维 PTFE 覆膜	聚酯纤维 PTFE 覆膜	聚酯纤维 PTFE 覆膜	聚酯纤维 PTFE 覆膜
压缩空气压力(Mpa)	0.4-0.6	0.4-0.6	0.4-0.6	0.4-0.6	0.4-0.6
压缩空气气缸(L/个)	10	10	10	10	15
集成箱容量(L)	300	300	300	300	500
噪音等级(dB)	90	90	90	90	95
过滤方式	负压外滤式	负压外滤式	负压外滤式	负压外滤式	负压外滤式
清灰方式	脉冲反吹+抽屜集尘	脉冲反吹+抽屜集尘	脉冲反吹+抽屜集尘	脉冲反吹+抽屜集尘	脉冲反吹+抽屜集尘
进风口口径(mm)	φ 150-300	φ 150-300	φ 150-300	φ 150-300	φ 200-600
排风口口径(mm)	φ 200	φ 200	φ 200	φ 200	φ 600
外形尺寸(mm)	1660 × 1510 × 3500	1660 × 1510 × 3500	1660 × 1510 × 3500	1660 × 1510 × 3500	2000 × 1250 × 3800
机器外观喷漆	碳钢喷塑涂装 工业灰+绿青				

### 概述 Summary

数控等离子激光切割机在运行过程中会产生大量的烟尘，严重污染环境，损害操作员工的身体健康，因此，必须采取局部通风及治理措施，将烟尘、粉尘等予以净化处理，使生产环境达到国家有关标准。我公司生产的ZYJC系列切割烟尘净化器，集国内外优质技术，除尘效果好，性价比高。

CNC plasma laser cutting machine will produce a lot of smoke and dust in the course of operation, seriously polluting the environment, harming the health of the operators. Therefore, local ventilation and control measures must be taken to purify the smoke and dust, so that the production environment can meet the relevant national standards. Our company produces ZYJC series of cutting dust purifier, collection of high-quality technology at home and abroad, dust removal effect is good, cost-effective.



### 使用场所

小型工厂车间、吸铁屑、打磨粉尘、冶金、煤矿、设备配套等

### 概述 Summary

LH系列是一种工业移动吸尘器，功率从1.5~4.0kw，广泛使用于小型工厂车间、吸铁屑、打磨粉尘、冶金、煤矿、设备配套等。

LH series is a kind of industrial vacuum cleaner with power ranging from 1.5 kW to 4.0 kw. It is widely used in small factory workshops, iron chips, grinding dust, metallurgy, coal mines, equipment matching and so on.

### 性能特点 Performance characteristics

- 采用工业级旋涡气泵，欧标电机50HZ 60HZ 双频设计；
  - 配有大型轮子，便于机身移动；
  - 可以连续24小时工作；
  - 高密度覆膜过滤器，过滤精度高达0.3微米；
  - 100L容量，更便捷的自卸分离桶；
  - 配有旋风分离器；分离效率为97%；
  - 采用全自动脉冲反清灰装置；
  - 带有过载、过流、装置及远程启动系统；
- The European standard motor 50HZ 60HZ dual-frequency design is adopted in Europe. Is equipped with extra large wheels, easy to move the body;
  - Positive can work 24 hours in a row;
  - High density mulch filter with filtration accuracy up to 0.3 micron;
  - 100L capacity, more convenient self-discharging separating barrel;
  - Plus cyclone separator;
  - The separation efficiency was 97%.
  - The full-automatic pulse back cleaning device is used in the high pressure area.
  - The tank is equipped with overload, overcurrent, device and remote start system;

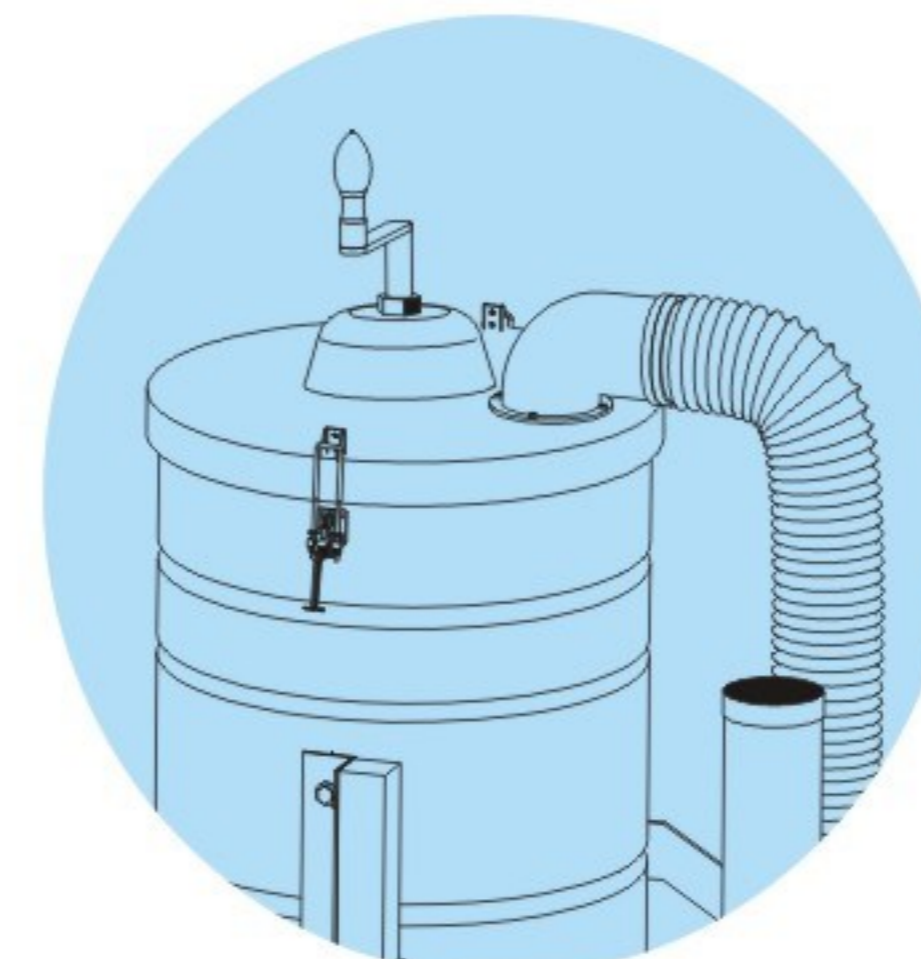
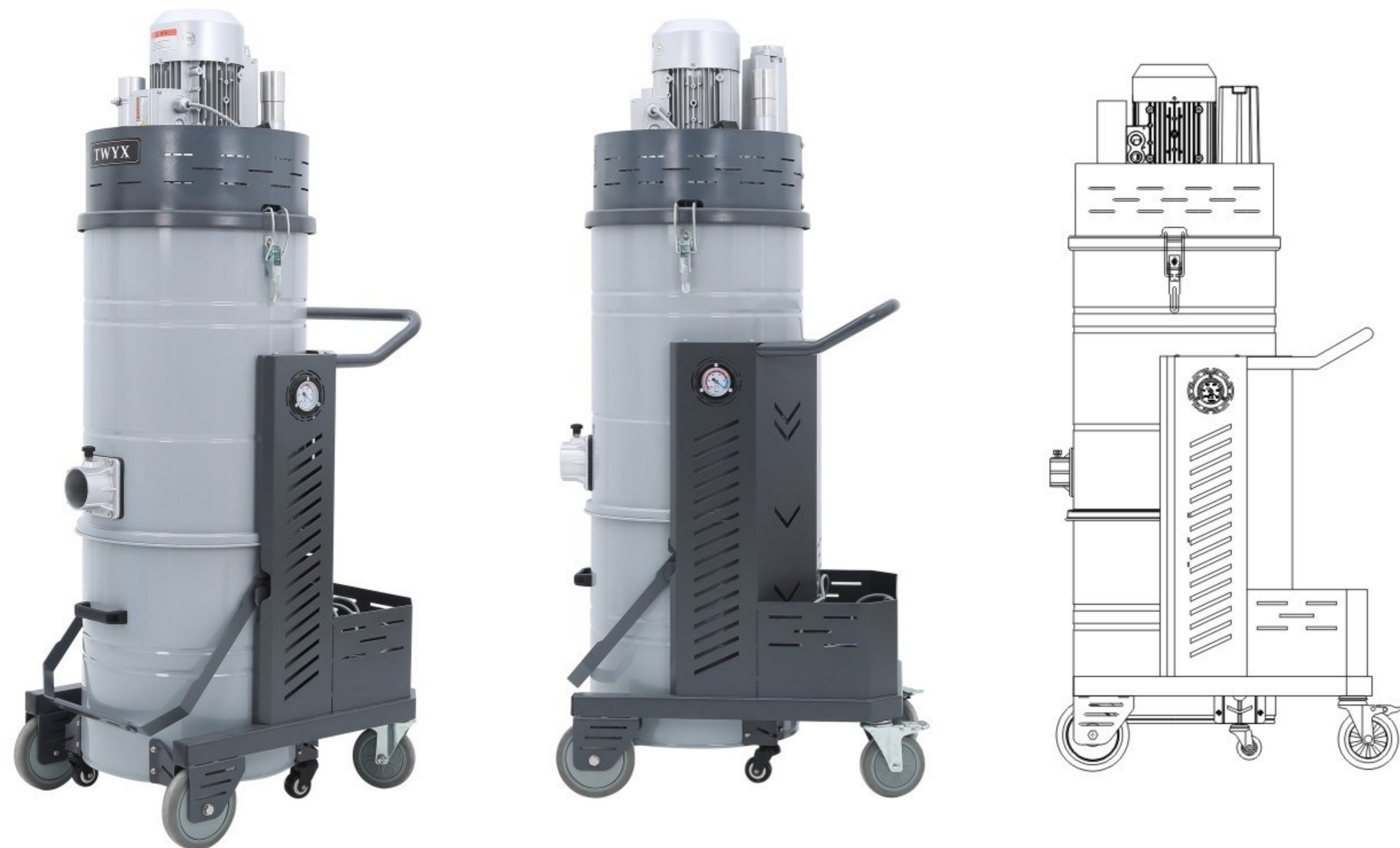

手摇拨片除尘(SYBP)  
Hand picking dust removal (SYBP)



自动脉冲反吹除尘(MCFC)  
Automatic pulse back blow dusting (MCFC)



手压反吹除尘(SDFC)  
Hand pressure reverse blowing dust removal (SDFC)



旋风分离除尘+超声波震动除尘(ZDCX)  
Cyclone separation dust removal + ultrasonic vibration dedusting (ZDCX)



星形布袋除尘(BDCX)  
Star bag dust removal (BDCX)

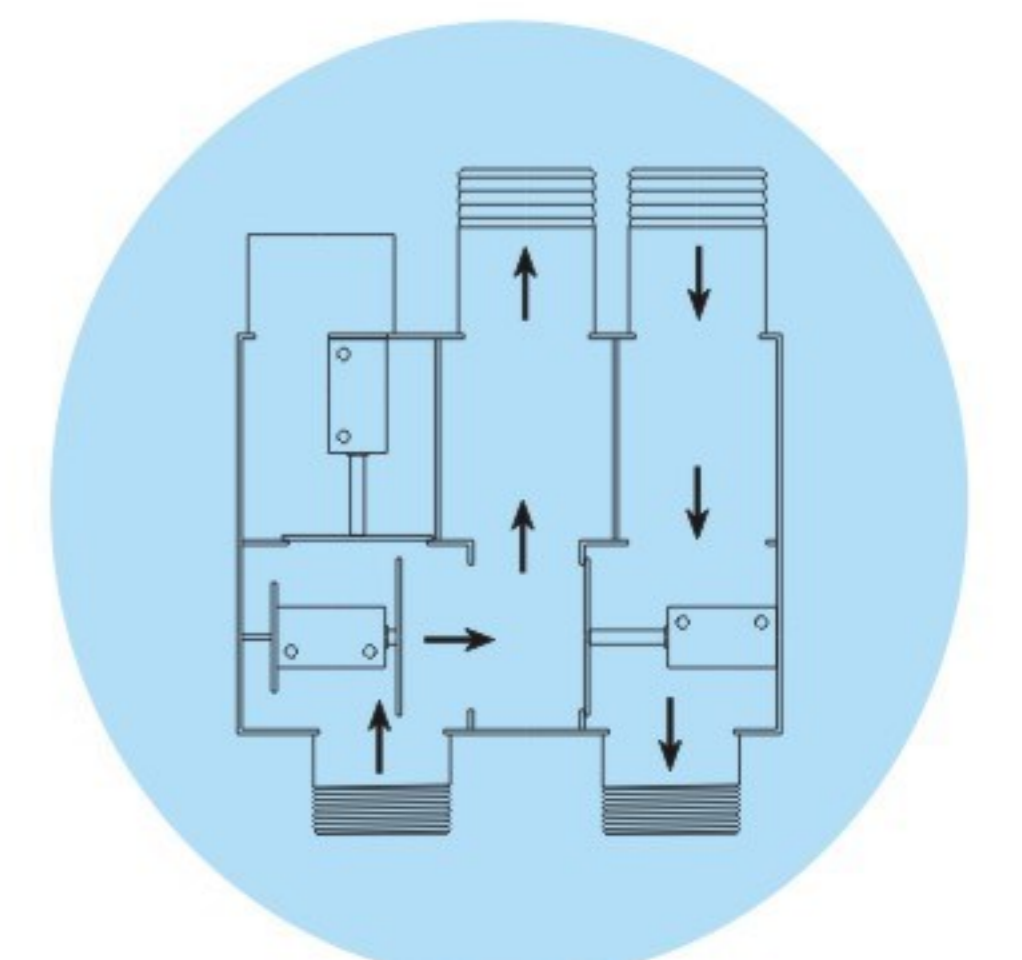

风泵自反吹装置除尘(ZFC)  
Air pump self blowing device dust removal (ZFC)

### 技术参数 Technical parameters

型号 Model	尘桶容量 Volume (L)	电压 Voltage (V)	功率 Power (KW)	吸力 Max. Vacuum (kPa)	风量 Airflow (m <sup>3</sup> /h)	噪音 Noise (dB)	重量 Weight (kg)	过滤面积 Filter area (m <sup>2</sup> )	吸尘口径 Suction caliber (mm)	尺寸 Dimensions L × W × H (mm)
LH1500	100	220/380-480	1.5	18	320	69		3.0	φ 50	1060 × 465 × 1050
LH2200	100	220/380-480	2.2	21	320	69		3.0	φ 50	1060 × 465 × 1050
LH3000	100	380-480	3.0	27	420	69		3.0	φ 50	1060 × 465 × 1050
LH4000	100	380-480	4.0	29	420	69		3.0	φ 50	1060 × 465 × 1050

# 应用案例

Application case



# 应用案例

Application case



蜚誉全球  
日丽风清

